

Thermal Imaging Bullet Network Camera User Manual

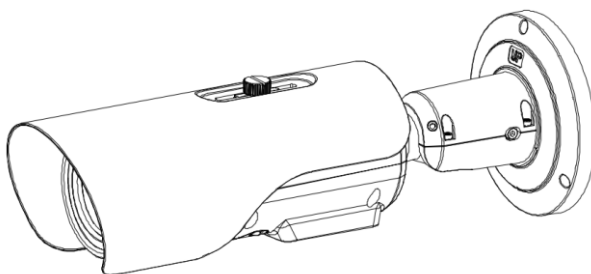

Issue

V1.0

Date

2024-12-20





Precautions

Precautions

Fully understand this document before using this device, and strictly observe the rules in this document when using this device. If you install this device in public places, put a sign "You have entered the area of electronic surveillance" in an eye-catching place. Failure to correctly use electrical products may cause fire and severe injuries. To prevent accidents, carefully read the following context:

Symbols

This document may contain the following symbols whose meanings are described accordingly.

Symbol	Description
 DANGER	Indicates a high potential hazard which, if not avoided, will result in death or serious injury.
 WARNING	Indicates a medium or low potential hazard which, if not avoided, could result in slight or moderate injury.
 CAUTION	Indicates a potential risk which, if not avoided, could result in property damage, data loss, lower performance, or unpredictable result.
 TIP	Provides methods to help you solve a problem or save you time.
 NOTE	Provides additional information to emphasize or supplement important points of the main text.

DANGER

To prevent electric shocks or other dangers, keep power plugs dry and clean.

WARNING

Strictly observe installation requirements when installing the device. The manufacturer shall not be responsible for device damage caused by users' operation of non-conformance.

Strictly conform to local electrical safety standards and use power adapters which are marked with the LPS standard when installing and using this device. Otherwise, this device may be damaged.

Use accessories delivered with this device. The voltage must meet input voltage requirements for this device.

If this device is installed in places with unsteady voltage, ground the device to discharge high energy such as electrical surges in order to prevent the power supply from burning out.

When this device is in use, ensure that no water or any liquid flows into the device. If water or liquid unexpectedly flows into the device, immediately power off the device and disconnect all cables (such as power cables and network cables) from this device.

Do not place the thermal imaging camera and unpackaged products at a radiation source with a high intensity regardless of whether the device is in the normal power-on state, for example, the sun, laser, and electric arc welder. Do not place the thermal imaging camera and unpackaged products against objects with a high heat source, for example, the sun. Otherwise, the accuracy of the thermal imaging camera will be affected. In addition, the detector in the thermal imaging camera may be permanently damaged.

If this device is installed in places where thunder and lightning frequently occur, ground the device nearby to discharge high energy such as thunder strikes in order to prevent device damage.



CAUTION

Unless otherwise specified in the user manual, do not use the thermal imaging camera in an environment with the temperature lower than -40°C (-40 F) or higher than 60°C ($+140\text{ F}$). Otherwise, the images displayed by the thermal imaging camera are abnormal and the device may be damaged because of working beyond the temperature range for a long period.

As for the outdoor installation, avoid the morning or evening sunlight incidence to the lens of the thermal imaging camera. The sun shade must be installed and adjusted according to the angle of the sunlight illumination.

During transportation and storage, avoid damage to products caused by heavy pressure, severe vibration and soaking. The warranty does not cover any device damage that is caused during secondary packaging and transportation after the original packaging is taken apart.

This device is sensitive to static. Improper static may damage the thermal imaging camera. ESD protection measures and reliable grounding must be well prepared for device installation and uninstallation.

Protect this device from fall-down and intensive strikes, keep the device away from magnetic field interference, and do not install the device in places with shaking surfaces or under shocks.

Clean the device body with a soft and dry cloth. In case that the dirt is hard to remove, use a dry cloth dipped in a small amount of mild detergent and gently wipe

the device, and then dry it again. Pay special attention to the front window of the thermal imaging camera because this is precision optics. If the front window has water spots, use a clean and soft cloth moistened with water and wipe it. If the front window needs further cleaning, use a soft cloth dampened with isopropyl alcohol or detergent. Improper cleaning can cause damage to the device.

The lens window of the thermal imaging camera is designed to be applicable to an outdoor environment. The window is coated with durable coating material, but may require frequent cleaning. When you found lens image degradation or excessive accumulation of pollutants, you should clear up the window in a timely manner. Exercise caution when you use this device in severe sandstorm (such as deserts) or corrosive environments (such as offshore). Improper use may cause surface coating off.

Do not jam the ventilation opening. Follow the installation instructions provided in this document when installing the device.

Keep the device away from heat sources such as radiators, electric heaters, or other heat equipment.

Keep the device away from moist, dusty, extremely hot or cold places, or places with strong electric radiation.

If the device is installed outdoors, take insect- and moisture-proof measures to avoid circuit board corrosion that can affect monitoring.

Remove the power plug if the device is idle for a long time.

Before unpacking, check whether the fragile sticker is damaged. If the fragile sticker is damaged, contact customer services or sales personnel. The manufacturer shall not be held responsible for any artificial damage of the fragile sticker.

Special Announcement

All complete products sold by the manufacturer are delivered along with nameplates, operation instructions, and accessories after strict inspection. We shall not be responsible for counterfeit products.

The manual may contain inaccurate information of function and operation, misprints. The manufacturer will update this manual according to product function enhancement or changes and regularly update the software and hardware described in this manual. Updated information will be added to new versions of this manual without prior notice.

Pictures for reference only, subject to our available products.

Contents

Precautions	i
Contents	iv
1 Product Overview	6
1.1 Thermal Imaging Principles and Advantages	6
1.2 Device Structure	6
1.3 Device Dimensions	8
1.4 Out Wire Connection	12
1.4.1 The Multi-connector Cables	13
1.4.2 Integrated Cable Management Bracket	15
1.5 Packing List	16
1.6 Installation	17
1.6.1 Preparations	17
1.6.2 Installation Mode	17
1.6.2.1 Installing Bracket A Without Junction Box	18
1.6.2.2 Installing Bracket B With Junction Box	20
2 Device Login	24
2.1 Login and Logout	24
2.2 Change Password	27
2.3 Homepage Layout	28
2.4 Playback	31
2.5 IVS Setting	35
3 Quick Start Settings	36
3.1 Local Network	36
3.2 Video	39
3.3 Image Display	42
3.3.1 Mode	42
3.3.2 Image	43
3.3.3 Scene	44
3.3.4 Set Pseudocolor	44
3.3.5 FFC Control	46
3.3.6 Noise Reduction	48
3.3.7 Image Enhancement	49

3.4 OSD	49
3.5 Date and Time.....	52
4 Configuring Thermal	54
4.1 Settings	54
4.1.1 Temperature Parameters.....	54
4.1.2 Ambient Temperature.....	60
4.1.3 Privacy Zone Masking	60
4.1.4 Defect Pixel Correction	61
4.1.5 Version Information	63
4.2 Temperature Alarm	63
4.3 Schedule Linkage	69
5 IVS Settings.....	72
5.1 AI Multi-Target.....	72
5.2 Intelligent Analysis	73
5.2.1 Intrusion.....	73
5.2.2 Smart Motion.....	76
5.2.3 Single Line Crossing.....	76
5.2.4 Double Line Crossing.....	78
5.2.5 Multi-Loitering	80
5.2.6 Wrong -Way.....	80
5.2.7 Enter Area.....	81
5.2.8 Leave Area.....	82
5.3 Environmental Safety Analysis.....	83
5.3.1 Smoking Detection	83
5.3.2 Fire Spot Detection.....	84
5.4 People Counting	86
5.4.1 Set.....	86
5.4.2 Report	88
A Troubleshooting	90
B Common Emission Rate	92

1 Product Overview

1.1 Thermal Imaging Principles and Advantages

For any object, as long as its temperature is above the absolute zero (-273.15°C), although the object does not give out light, it can radiate infrared. The infrared is also known as thermal radiation. A temperature change occurs when the infrared radiated by objects at different temperatures is absorbed by the infrared thermal detector, and thereby generating an electrical effect. An electrical signal is amplified and processed to obtain a thermal image corresponding to the distribution of heat on the surface of the object, that is, infrared thermal imaging.

Applicable to any light environment

Traditional cameras rely on the natural or ambient light for imaging. However, the infrared thermal imaging camera can clearly image the object with the infrared heat radiation of the object without relying on any light. The infrared thermal camera is applicable to any light environment and is free from glare impact. It can clearly detect and find the target as well as identify the camouflaged and hidden target in both day and night. Therefore, it achieves real 24-hour surveillance.

Monitoring the temperature field of the target heat distribution

The infrared thermal camera can display the temperature field of the object and change the surface temperature distribution of the object that cannot be directly seen by human eyes to the thermal image representing the surface temperature distribution of the object. By monitoring the temperature field, you can immediately identify the temperature abnormality, thereby preventing potential risks caused by the temperature, such as fire.

Providing the cloud penetration capability

Atmosphere, dust, and clouds can absorb visible light and near-infrared, but are clear to the thermal infrared for 3 to 5 microns (medium wave infrared region) and 8 to 14 microns (long wave infrared). Therefore, it is difficult for the conventional cameras to capture clear images under dense clouds, while the thermal imaging camera is able to effectively penetrate the atmosphere and clouds to capture clear images.

1.2 Device Structure

Figure 1-1 shows the rear panel of the Thermal Imaging Network Bullet Camera. For details of the interfaces, see Table 1-1.

Figure 1-1 Appearance and interfaces of the camera 1

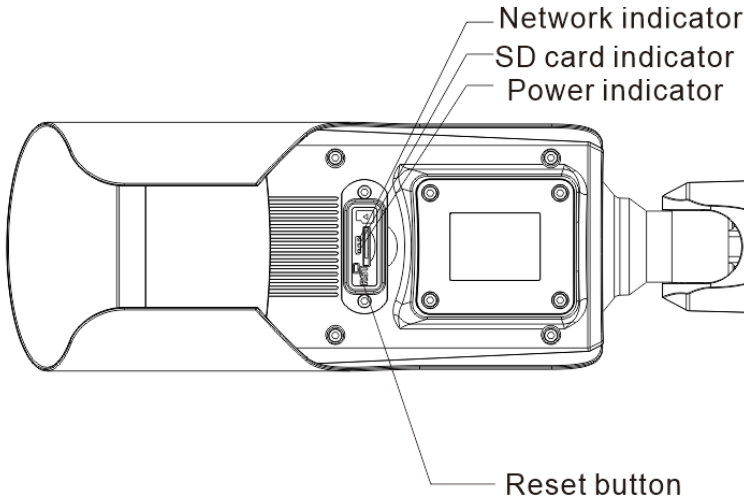
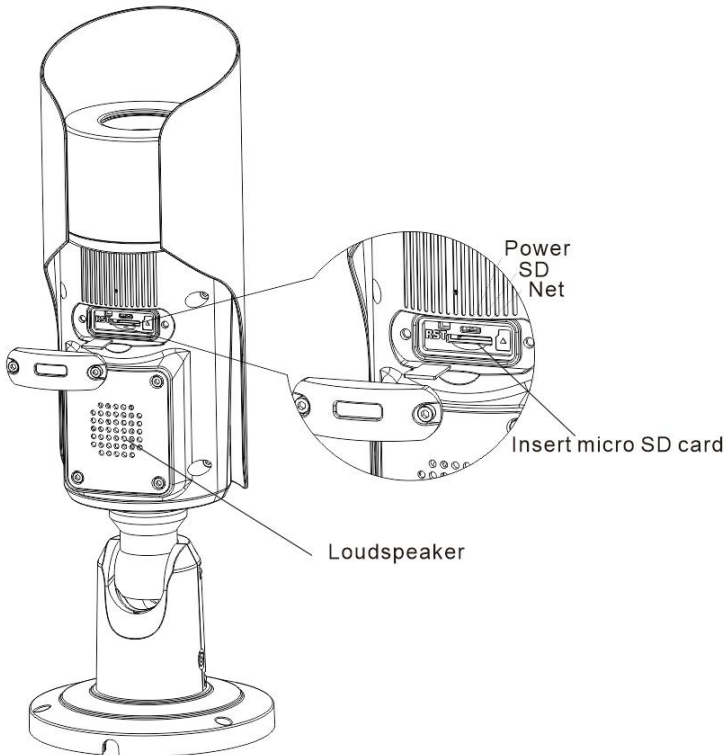

Table 1-1 Interfaces of Device

No.	Physical Interface	Connection
1	Network indicator	The network is working normally, the light is on; When it is transferring data, the light is splash.
2	SD card indicator	The SD indicator has the following states: OFF: The Micro SD card is not inserted. ON: The Micro SD card is inserted.
3	Power indicator	The power supply is plugged and works normally, the red light is on.
4	Reset button (RESET)	The configuration resumes to the factory settings after you press the reset button for 5s. The default value is 192.168.0.121.
5	SD card slot	It places the SD card. Note: When you install the micro SD card, ensure that the micro SD card is not in the write-protection state and then insert the micro SD card in the slot.

No.	Physical Interface	Connection
		<p>When you remove the micro SD card, ensure that the micro SD card is not in the write-protection state. Otherwise, the data may be lost or the micro SD card may be damaged.</p> <p>When hot plugging the micro SD card, stop recording and then perform the corresponding operation.</p>

Figure 1-2 Appearance and interfaces of the camera 2



1.3 Device Dimensions

The different brackets of device are having different dimensions, please refer to actual product.

Figure 1-3 The A bracket dimensions (unit: mm)

F50/35/25

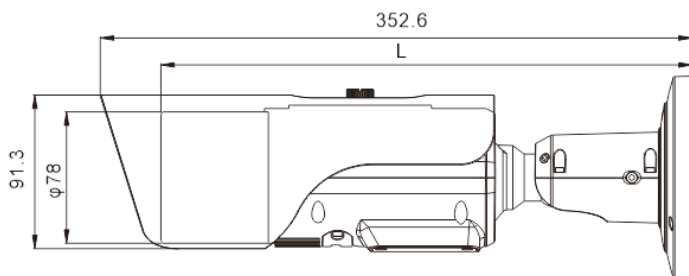

F50	L=316.5mm
F35	L=305.3mm
F25	L=296.8mm

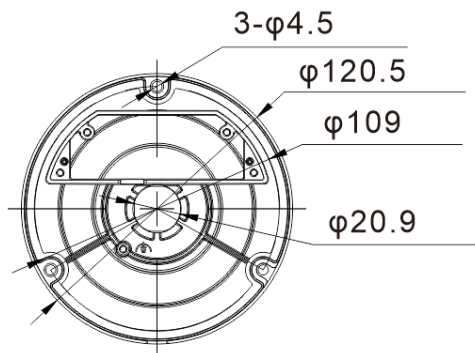
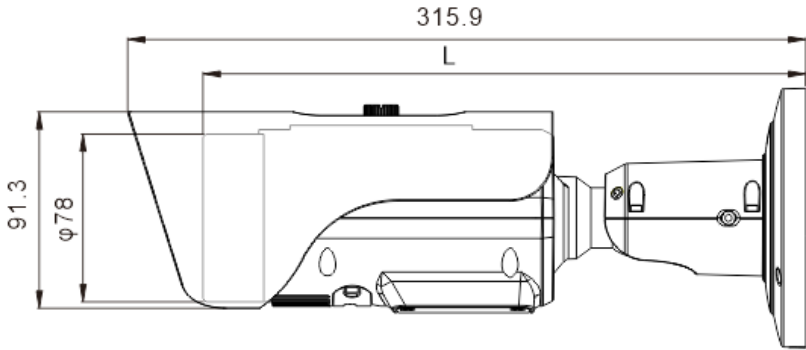

Figure 1-4 The A-1 bracket with junction box Dimensions (unit: mm)

F 15/9



F15/F9 L=280.8mm

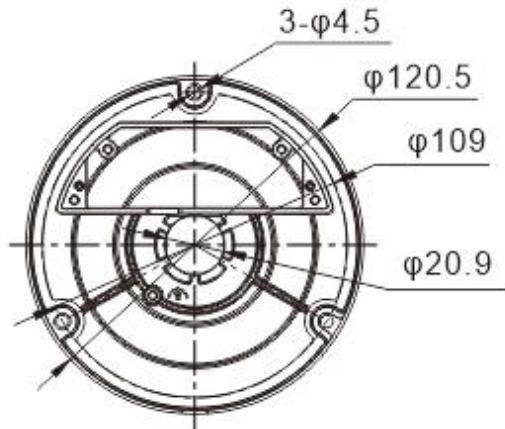
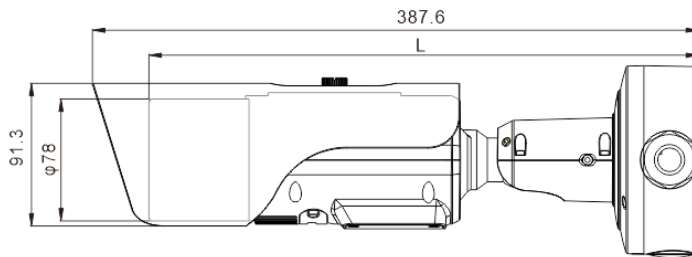

Figure 1-5 The B bracket with junction box dimensions (unit: mm)

F50/35/25



F50 L=351.5mm

F35 L=340.3mm

F25 L=331.8mm

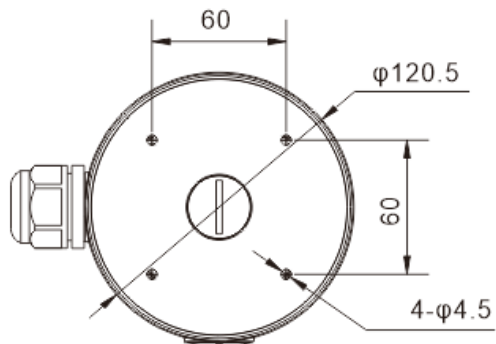
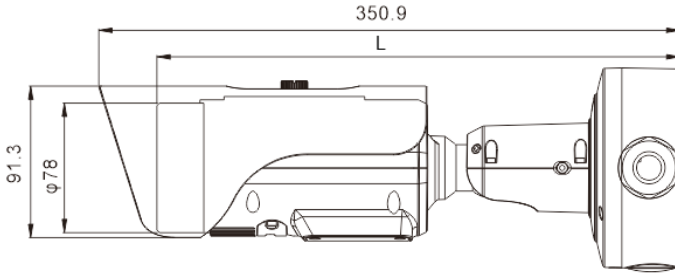
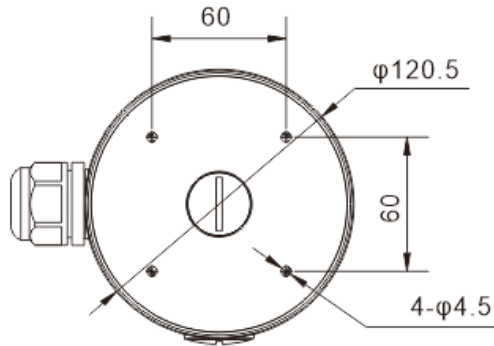

Figure 1-6 The B bracket with junction box dimensions (unit: mm)

F15/9



F15/F9 L=315.8mm



1.4 Out Wire Connection

There are two ways to connect the Thermal Imaging Network Bullet Camera, the multi-core cables and the integrated cable management bracket. Users can choose the corresponding method and installation method according to their bracket.

1.4.1 The Multi-connector Cables

The following three figures show the multi-core cables of the Thermal Imaging Network Bullet Camera. The different models have the different multi-core cables, please refer to actual product. For details of the multi-connector combination cable, please refer to Table 1-2.

Figure 1-7 Multi-core cables 1

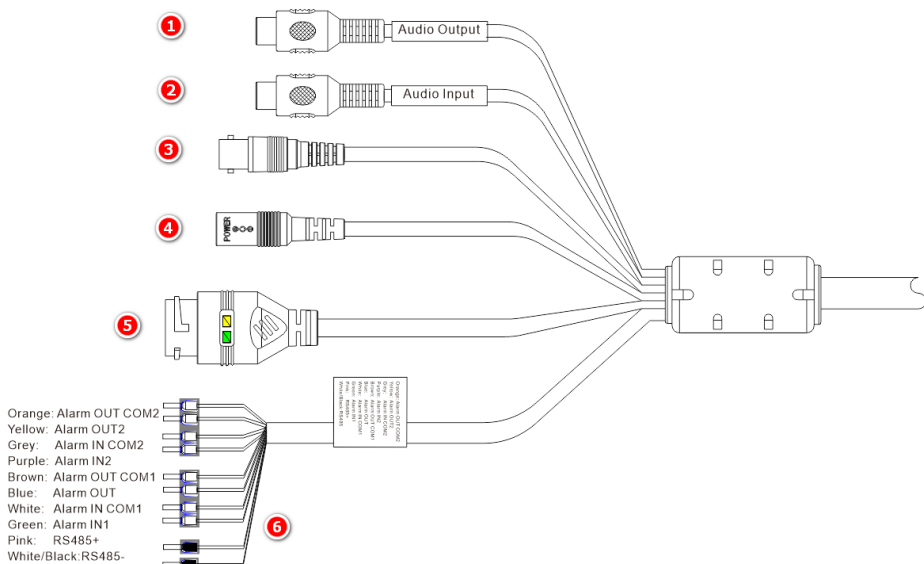

Table 1-2 Multi-core cables 1

ID	Core of Cable	Functions	Connection
1	--	Audio output	Connect to the external audio device such as the voice box.
2	--	Audio input port (cable input)	Input the audio signal and receives the analog audio signals from the sound pick-up device.
3	--	CVBS	Analog video output.
4	--	DC12V /AC 24V	Power interface, connect to the 12 V DC (AC 24V) power supply.
5	--	Network interface	Connect to the standard Ethernet cable.

ID	Core of Cable	Functions	Connection
6	Orange	Alarm out com 2	Connect to the alarm devices.
	Yellow	Alarm out 2	
	Grey	Alarm in com 2	
	Purple	Alarm in 2	
	Brown	Alarm out 1com	
	Blue	Alarm out 1	
	white	Alarm in 1 com	
	Green	Alarm in 1	
	Pink	RS485+	
	Black / white	RS485-	

1.4.2 Integrated Cable Management Bracket

Figure 1-8 Integrated cable management bracket port

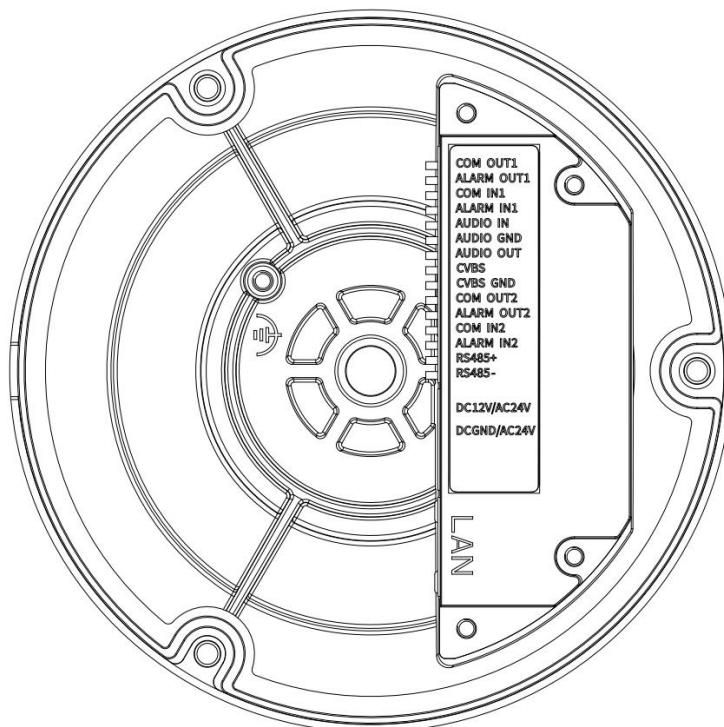

Table 1-3 Integrated cable management bracket port

Port Name	Description	Remark
COM OUT 1	Alarm out com 1	
ALARM OUT1	Alarm out 1	
COM IN 1	Alarm in 1 com	
ALARM IN1	Alarm in 1	
AUDIO IN	input port (cable input)	Applied for audio devices.
AUDIO GND	Audio port GND	
AUDIO OUT	Audio output	

CVBS	Analog video output.	
CVBS GND	Analog video output ground port.	
COM OUT2	Alarm out com 2	
ALARM OUT2	Alarm out 2	
COM IN2	Alarm OUT com 2	
ALARM IN2	Alarm in 2	
RS485+	RS485+	Applied for connecting to external PTZ
RS485-	RS485-	
DC 12 V/AC24 V	DC 12 V +	Support AC 24V
DC GND/AC24 V	DC 12V -	
LAN	Network port, connect to internet. Support PoE supply.	

1.5 Packing List

Unpack and check the appearance of product for no obvious damage, and confirm the item list for Table 1-4 is consistent.

Table 1-4 Packing list

Item	Quantity	Remark
Thermal camera	1	
User manual	1	
Installation location label	1	
Network interface protect cover	1	
Plastic anchor	3/4	
Self-tapping screw	3/4	
Allen Key	2	Two types
T15 wrench	1	Configured for





Plug and sealing ring	2	junction box
Cable gland	1	
Junction box and accessories	1	

1.6 Installation

1.6.1 Preparations

Tools needed (Not included) and supplied parts are shown in Table 1-5.

Table 1-5 Installation tools

Tools	Appearance
Phillips screwdriver (Not included)	
Claw hammer (Not included)	
Hammer drill (Not included)	
Spirit level (Not included)	
Hex Allen L-wrench (Included)	
Self-tapping screw (Included)	
Plastic anchor (Included)	

1.6.2 Installation Mode

The thermal imaging network bullet camera can be installed on the ceiling or the wall. You can select the appropriate installation according to your requirements. If the camera needs to be installed on the cement wall, you need to install the expansion screws (the mounting holes of the screws must be consistent with that of the support), and then install the support.

 **NOTE**

The wall where the support is mounted must be able to withstand at least three times of the total weight of the support and the camera.

The different brackets have different installation methods, please choose the corresponding method according to the purchased product.

1.6.2.1 Installing Bracket A Without Junction Box

Step 1 Take out the installation location label from the package, stick it on the ceiling or the wall. According to the location hole positions shown in the installation location label, punch three location holes on the ceiling or the wall.

Step 2 Drive the plastic anchors into the holes, as shown in Figure 1-9.

 **NOTE**

If you choose the back leading mode, drill a leading-out hole on the ceiling or the wall, as shown in the area highlighted. (This manual uses the back leading mode as an example.)

If you choose the side leading mode, lead the multi-connector combination cable from the side notch on the bottom of the camera.

Figure 1-9 Installation location label

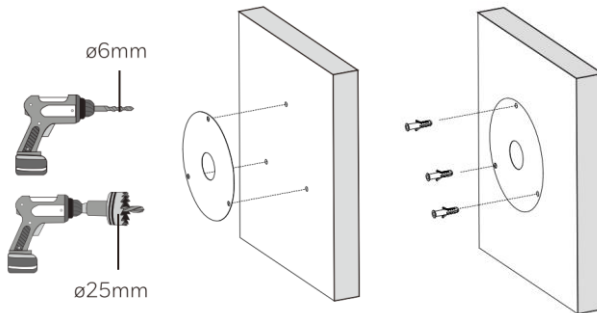

Step 3 Align the holes in bracket with the plastic anchors in ceiling or wall.

Step 4 Connect the multi-core cables. Loosen the screw 1 and screw 2, adjust the surveillance angle, as shown in Figure 1-12

Figure 1-10 Connect the multi-core cables

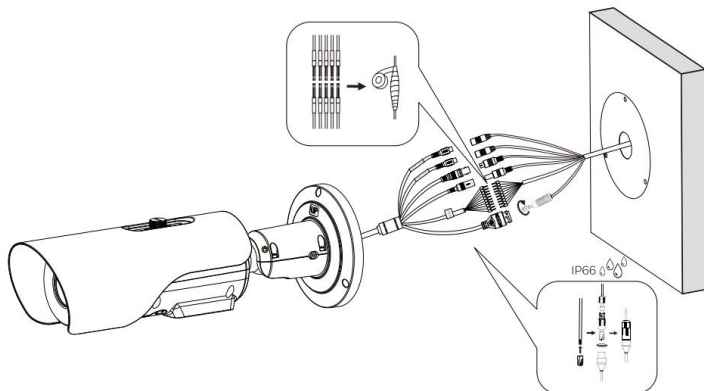

Step 5 Fix the bracket with self-tapping screws, as shown in Figure 1-11.

Figure 1-11 Fixing camera

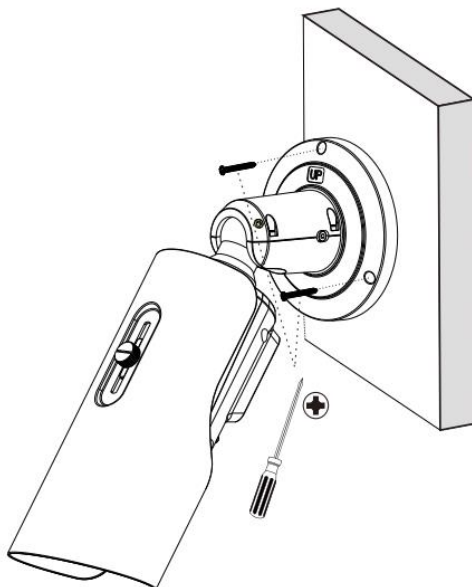

Step 6 After adjusting angle, fix screws in turn to finish installation, as shown in Figure 1-12.

Figure 1-12 Adjust the surveillance angle

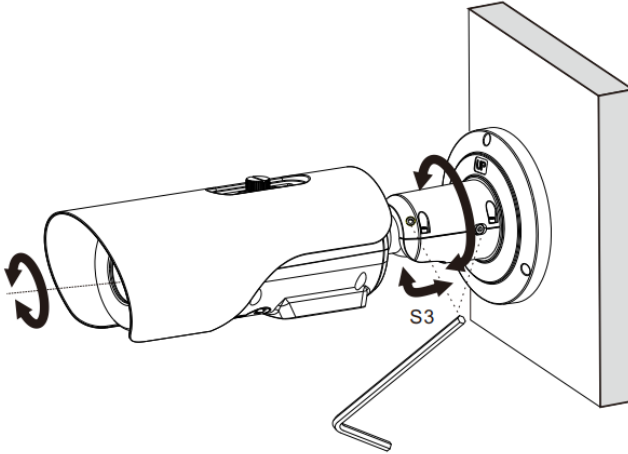

---End

1.6.2.2 Installing Bracket B With Junction Box

Step 1 Take out the installation location label from the package, stick it on the ceiling or the wall. According to the location hole positions shown in the installation location label, punch four location holes on the ceiling or the wall.

Step 2 Drive the plastic anchors into the holes, fix the junction box by self-tapping screws, as shown in Figure 1-13.

Figure 1-13 Fixing the junction box

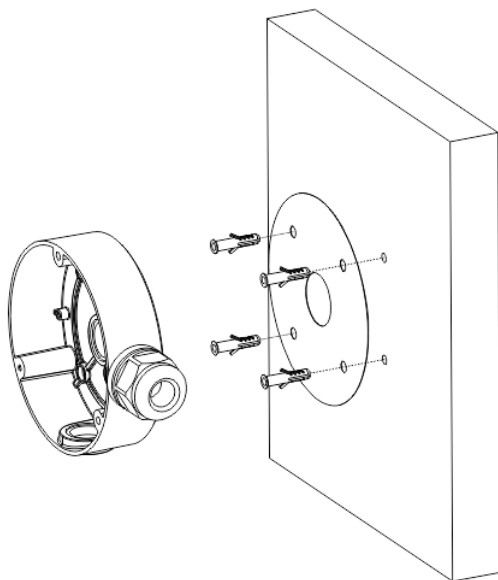

Step 3 Wiring of junction box. Align the holes in bracket with the box and fix the camera to the box with self-tapping screws, as shown in Figure 1-14.

Figure 1-14 Fix the camera to the junction box

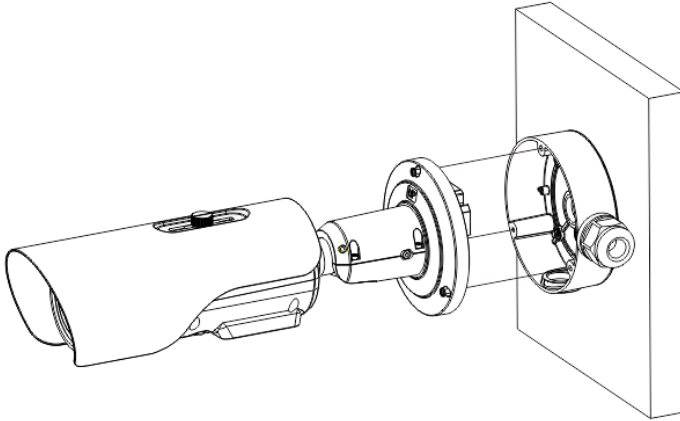

Step 4 Connect the multi connector cable. Loosen screw 1 and screw 2, adjust the surveillance angle, as shown in Figure 1-15.

Figure 1-15 Adjust the surveillance angle

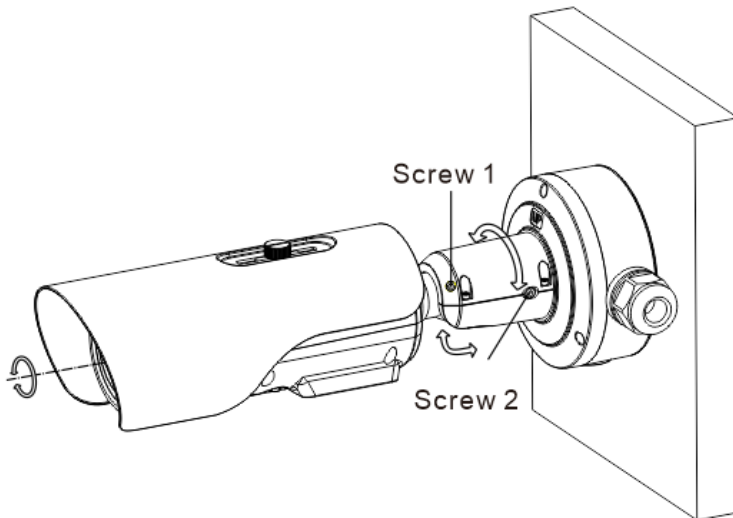

Step 5 After adjusting angle, fix screw 2 and screw 1 in turn to finish installation.

 **NOTE**

There are three pipe thread interface in the junction box, one of which needs to be used with cable gland, so our company provides two plugs.

Figure 1-16 Installing plug

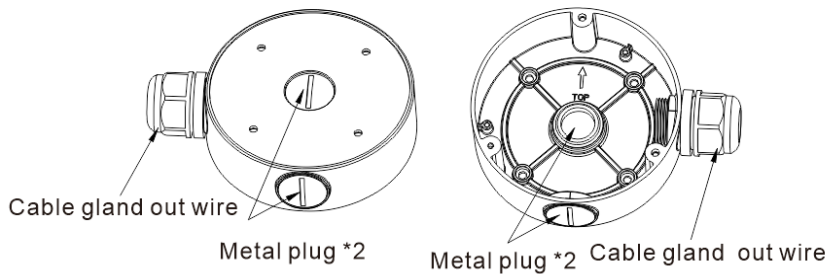

---End

2 Device Login

2.1 Login and Logout



CAUTION

To access the web interface through Microsoft Edge, Chrome or Firefox browser; Otherwise some functions may be unavailable.

Login

Step 1 Open Chrome browser, enter the IP address of the IP camera (default value: 192.168.0.121) in the address box, and click on the **Enter** button.

Step 2 Create password when you login for the first time, then jump to the login interface.

Figure 2-1 Create password

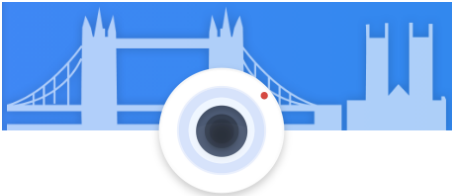

Please Create Password

English ▾

User Name

New Password ?

Please Input New Password

Confirm

Create

Step 3 Enter the user name and password. The login page is displayed, as shown in Figure 2-2.

Figure 2-2 Login page

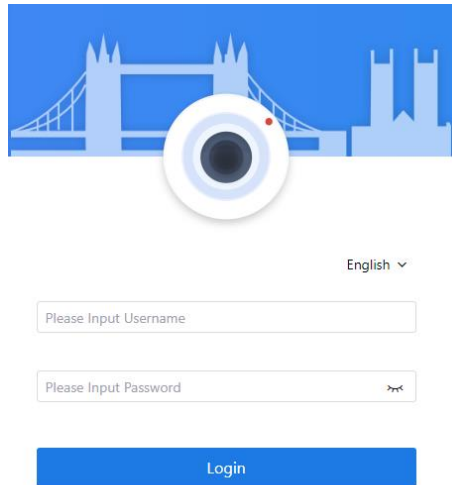
The image shows a login page with a blue header featuring a stylized white bridge and camera lens icon. Below the header, there is a language dropdown menu set to 'English'. Two input fields are present: 'Please Input Username' and 'Please Input Password' with a password toggle icon. A blue 'Login' button is at the bottom. **NOTE**

- The default username is admin. Users should create the password for the first time login.
- DHCP is on by default. Please use tool to search IP, the default IP address is 192.168.0.121.
- After modifying password, you need to wait at least three minutes then power off to make sure modify it successfully. Or login the Web again to test the new password.
- You can change the system display language on the login page.

Step 4 Click **Login** to enter the homepage.

---End

Sign out

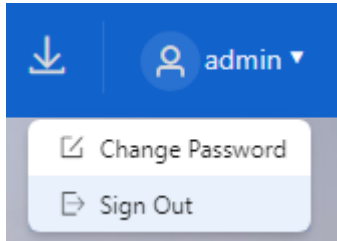

Click **Sign Out** in the upper right to return to login page.

2.2 Change Password

Description

Step 1 Click the username on the upper right, choose **Change Password** to enter the change password page as shown in Figure 2-3. Or choose **Setting > System > Change Password**.

Figure 2-3 Change the default password page

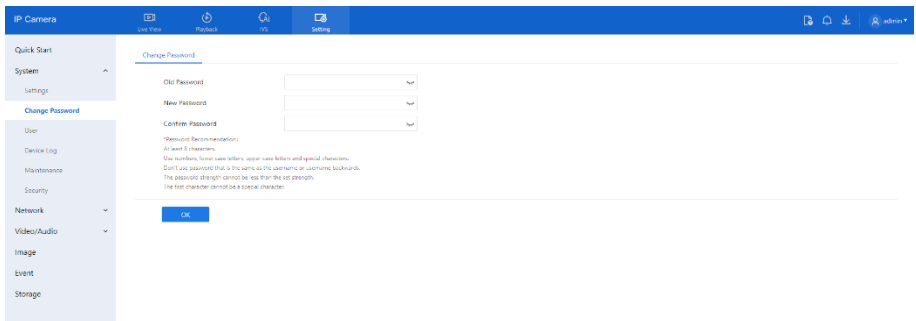

Step 2 Input the old password, new password, and confirm password.

Step 3 Click **OK**.

If the message "Change your password success!" pops up, the password is successfully changed. If the password fails to be changed, there will be some tips for changing password. (For example, the new password length couldn't be less than eight.)

It is advised to restart the device three minutes later after modifying password.

Step 4 Click **OK**. The login page is displayed.

----End

2.3 Homepage Layout













On the homepage, you can view real-time videos, receive alarm and fault notifications, set parameters, change the password, and log out of the system. The figure shows the homepage layout. Table 2-1 describes the elements on the homepage.

Figure 2-4 Homepage layout



Table 2-1 Elements on the homepage

No.	Element	Description
1	Live View	Real-time videos are played in this page.
2	Playback	You can query the playback videos in this area. NOTE Only when the SD card or NAS has videos can you query the playback videos.
3	IVS setting	Intelligent Video System, set the ai multi-target, intelligent analysis (intrusion, smart motion, single line crossing, double line crossing, multi-loitering, wrong-way, general parameters), people counting and so on

No.	Element	Description
4	Thermal	Set the parameters of thermal, such as temperature parameter, temperature alarm, schedule linkage, led control and so on.
5	Setting	You can choose a menu to set device parameters, quick start, system, network, audio /video, image, event, and storage.
6		About the intercom function.
7		When the device accepts an alarm signal, the alarm icon will display  . You can click  to view the alarm information.
8		SD card video backup and download status.
9	 admin ▾	Current user, sign out or change password.
10		Set brightness, saturation, contrast and sharpness.
11		Window scale, switch the scale of play live video.
12		Full screen, click the icon to play live video at full screen.
13		Stream, click icon to switch stream. There are two modes stream.
14		Pause/Start. Close live video or play live video.
15		Audio. Open or close audio.







No.	Element	Description
16		Two-way audio. Open or close intercom, the computer should be plugged in microphone in advance.
17		Click the icon to snapshot the video and save the images to the specified location.
18		Record the video and save the file to the specified location.
19		<div data-bbox="506 454 789 587" style="background-color: #333; color: white; padding: 5px;"> <p>Target Frame</p> <p>Intelligent marking</p> </div> <p>Target frame: when detect the target, it will show frame on target.</p> <p>Intelligent marking: the detection area frame of the intelligent analysis in IVS will be displayed in the live video interface.</p>
20		Frame rate / resolution / bit rate / video encode type.
21		<p>I/O output, control the I/O alarm output manually. Click <div data-bbox="672 853 916 938" style="background-color: #333; color: white; padding: 5px; display: inline-block;">Open Close</div> to open alarm or close the alarm.</p>

Figure 2-5 About the intercom function



2.4 Playback



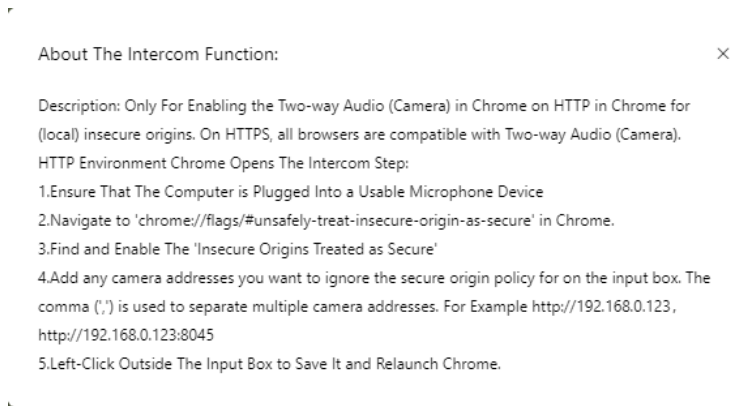



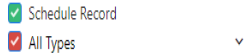

Click “Playback” at web interface. If users install micro SD card, and there are videos in SD card. Click “Playback” and the playback video will show as in Figure 2-6.

Figure 2-6 Playback page



Table 2-2 Playback function

No.	Element	Description
1	Channel	The channel list of cameras.
2	Calender	 the green point means it has recording video. Set the time to play recording.

3	 <p> <input checked="" type="checkbox"/> Schedule Record <input checked="" type="checkbox"/> All Types </p>	<p>All Types</p> <p>I/O Alarm</p> <p>Motion Alarm</p> <p>Day/Night Switch Alarm</p> <p>Abnormal Audio Alarm</p> <p>Intrusion</p> <p>Smart Motion</p> <p>Single Line Crossing</p> <p>Double Line Crossing</p> <p><u>Multi-Loitering</u></p> <p>The green timeline represents scheduled recording and the red timeline is alarm recording. The types of alarm recording vary according to model performance.</p>
4		<p>One screen plays recording. Choose one day has recording, click  to play.</p>
5		<p>Two screens play recording. Choose the screen, choose the channel, select one day which has recording(the date shows green point) , click  to play.</p>
6		<p>Four screens play recording. Choose the screen, choose the channel, select one day which has recording(the date shows green point) , click  to play.</p>
7		<p>Window scale, switch the scale of play recording video.</p>
8		<p>Full screen, click the icon to play recording video at full screen.</p>





9		Pause/Start. Close live video or play recording video.
10		Audio. Open or close audio.
11		Click the icon to snapshot the video and save the images to the specified location.
12		Fast Forward, 1/16X, 1/8 X, 1/4 X, 1/2 X, 1 X, 2 X, 4 X, 8 X
13		click the icon to start backup, drag the bar to download recording quickly, click the icon again to end up. The pop-up window of tip as shown in Figure 2-7, click the save to save the video. Click Cancel to abandon.
		
14		Time axis, users can choose 1h, 6h,12h, 24h.

Figure 2-7 Record backup tip

Tip

Begin Time

End Time

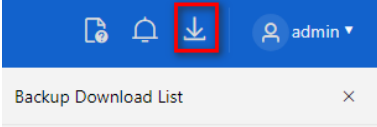
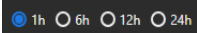
2.5 IVS Setting

Click IVS to enter IVS setting page, users can set the deep learning, intelligent analysis, behavior analysis as shown in Figure 2-8. The detail settings will be introduced at the following chapters.

Figure 2-8 IVS setting page

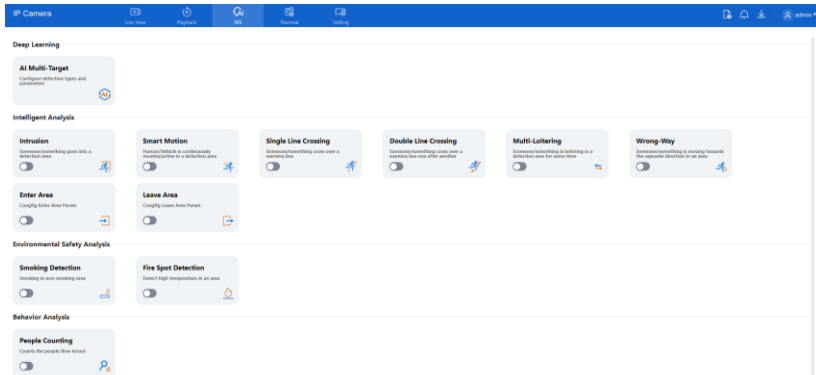

NOTE

The different models have different IVS functions, please refer to actual product.

---End

3 Quick Start Settings

For using the camera quickly, users to set the Local Network, Video, Display, OSD, Date and Time at Quick Start interface.

3.1 Local Network

Description

Local network parameters include:

- IP protocol
- IP address
- Subnet mask
- Default gateway
- Dynamic Host Configuration Protocol (DHCP)
- Preferred Domain Name System (DNS) server
- Alternate DNS server
- MTU

Procedure

Step 1 Choose **Setting > Quick Start > Local Network**.

The **Local Network** page is displayed, as shown in Figure 3-1.

Figure 3-1 Local network page

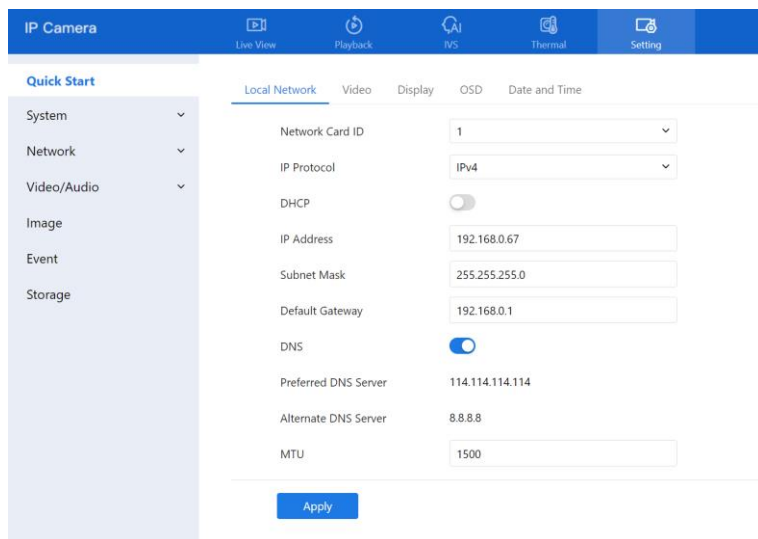

Step 2 Set the parameters according to Table 3-1.

Table 3-1 Local network parameters

Parameter	Description	Setting
Network Card ID	--	[Default value] 1
IP Protocol	IPv4 is the IP protocol that uses an address length of 32 bits. IPv6 is the IP protocol that uses an address length of 64 bits.	[Setting method] Select a value from the drop-down list box. [Default value] IPv4
DHCP	Enable DHCP, and the device will automatically obtain the IP address from the DHCP server.	[Setting method] Click the button on to enable DHCP . NOTE To query the current IP address of the device, you must query it on the platform based on the device name.

Parameter	Description	Setting
IP Address	Device IP address that can be set as required.	[Setting method] Enter a value manually. [Default value] 192.168.0.121
Subnet Mask	DHCP is off. Subnet mask of the network adapter.	[Setting method] Enter a value manually. [Default value] 255.255.255.0
Default Gateway	DHCP is off. This parameter must be set if the client accesses the device through a gateway.	[Setting method] Enter a value manually. [Default value] 192.168.0.1
Preferred DNS Server	DNS is on. IP address of a DNS server.	[Setting method] Enter a value manually. [Default value] 192.168.0.1
Alternate DNS Server	DNS is on. IP address of a domain server. If the preferred DNS server is faulty, the device uses the alternate DNS server to resolve domain names.	[Setting method] Enter a value manually. [Default value] 192.168.0.2
MTU	Set the maximum value of network transmission data packets.	[Setting method] Enter a value manually. NOTE The MTU value is range from 1280 to 1500, the default value is 1500, Please do not change it arbitrarily.

Step 3 Click **Apply**.

If the message "Apply success!" is displayed, and the system will save the settings. The message "Set network parameter success, please login system again" is displayed. Use the new IP address to login to the web management system.

If the message "Parameter is Invalid " is displayed, please set the parameters correctly.

---End

3.2 Video

Procedure

Step 1 Choose **Setting > Quick Start > Video**.

The **Video** page is displayed, as shown in Figure 3-2.

Figure 3-2 Video setting page

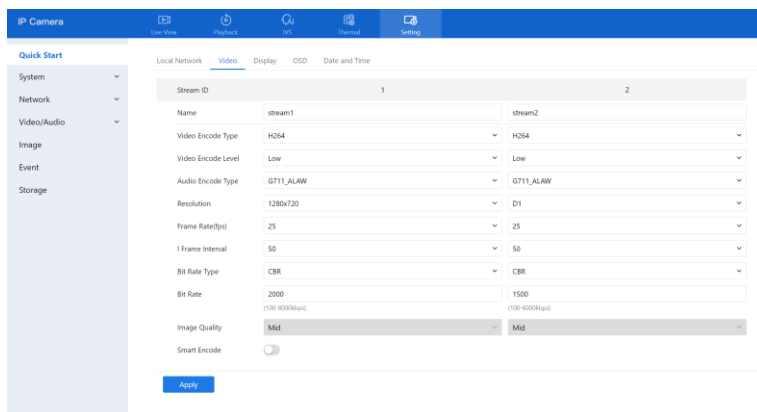

Step 2 Set the parameters according to Table 3-2.

Table 3-2 Parameters of stream configuration

Parameter	Description	Setting
Stream ID	The device supports at most three streams. Streams 1 and 2 adopt H.264 code. Stream 1 stands for the best stream performance of the device supports. Stream 2 usually offers comparatively low-resolution options.	[Setting method] Select a value from the drop-down list box.
Name	Stream name. NOTE The stream name consists of character, number, character and underline.	[Setting method] Enter a value manually. The value cannot exceed 32 bytes.

Parameter	Description	Setting
		[Default value] Stream 1
Video Encode Type	<p>The video encode determines the image quality and network bandwidth required by a video. Currently, the following encode standards are supported:</p> <p>MJPEG</p> <p>MJPEG is a standard intra-frame compression encode. The compressed image quality is good. No mosaic is displayed on motion images. MJPEG does not support proportional compression and requires large storage space. Recording and network transmission occupy large hard disk space and bandwidth. MJPEG is not applicable to continuous recording for a long period of time or network transmission of videos. It can be used to send alarm images.</p> <p>Only the low video encode level can be chosen.</p> <p>H.264</p> <p>H.264 consists of H.264 low Profile, H.264 Main Profile and H.264 High profile. The performance of H.264 High Profile is higher than that of H.264 Main Profile, and the performance of H.264 Main Profile is higher than that of H.264 Base Profile. If a hardware decoding device is used, select the appropriate encode based on the decoding performance of the device.</p> <p>H.264 High Profile has the highest requirements on the hardware performance, and H.264 Base Profile has the lowest requirements for the hardware performance.</p> <p>There are three level can be chosen</p> <p>H.265</p> <p>H.265 is the advanced video encoding standard. It's the improvement standard from H.264. H.265 improves the streams, encoding quality and algorithm complexity to make configuration optimization.</p> <p>Only the Mid video encode level can be chosen.</p>	<p>[Setting method] Select a value from the drop-down list box.</p> <p>[Default value] H.264 High Profile</p> <p>NOTE</p> <p>The H.264 High Profile encode means high requirements on the hardware. If the hard-decoding capability is low, use H.264 Main Profile or H.264 Base Profile.</p> <p>When users choose the MJPEG for Stream 1, some functions will be error, such as the videos of FTP upload may not be play correctly.</p>
Audio Encode	The following audio encode standards are supported:	[Setting method] Select a value from

Parameter	Description	Setting
Level	<p>G711_ULAW: mainly used in North America and Japan.</p> <p>G711_ALAW: mainly used in Europe and other areas.</p> <p>RAW_PCM: encode of the original audio data. This encode is often used for platform data.</p>	the drop-down list box.
Resolution	<p>A higher resolution means better image quality.</p> <p>NOTE</p> <p>IP cameras support different resolutions based on the model.</p>	<p>[Setting method]</p> <p>Select a value from the drop-down list box.</p>
Frame Rate(fps)	<p>Frame rate is the number of images, snapshots, or frames that a camera can take per second. The frames per second determine the smoothness of a video. A video whose frame rate is higher than 22.5 f/s is considered as smooth by human eyes.</p> <p>Frame rates for different frequencies are as follows:</p> <p>50 Hz: 1–25 f/s</p> <p>60 Hz: 1–30 f/s</p> <p>NOTE</p> <p>The frequency is set on the Device Configuration > Camera page. The biggest MJPEG coding format frame rate is 12 frames per second.</p>	<p>[Setting method]</p> <p>Select a value from the drop-down list</p>
I Frame Interval(f)	<p>I frame do not require other frames to decode.</p> <p>A smaller I frame interval means better video quality but higher bandwidth.</p>	<p>[Setting method]</p> <p>Select a value from the drop-down list</p>
Bit Rate Type	<p>The bit rate is the number of bits transmitted per unit of time.</p> <p>The following bit rate types are supported:</p> <p>Constant bit rate (CBR)</p> <p>The compression speed is fast; however, improper bit rate may cause vague motion images.</p> <p>Variable bit rate (VBR)</p> <p>The bit rate changes according to the image complexity. The encoding efficiency is high and the definition of motion images can be ensured.</p>	<p>[Setting method]</p> <p>Select a value from the drop-down list box.</p>

Parameter	Description	Setting
Bit Rate Range	Indicates the maximal value of the bit rate. the different models may have different ranges, please refer to actual product.	[Setting method] Enter a value manually.
Image Quality	The video quality the camera output.	[Setting method] Select a value from the drop-down list box.
Smart Encode	Smart Encode. Smart encode includes H.264 & H.265. The storage space will be reduced fifty percent when smart encode is enabled. Only main stream supports smart encode.	[Setting method] Click the button on to enable Smart Encode .

Step 3 Click **Apply**.

If the message "Apply success!" is displayed, the system will save the settings.

If the message "Apply failed!" is displayed, you must apply for the Parameter Configure permission from an administrator.

If a message indicating that the bit rate invalid is displayed, enter a new bit rate value.

---End

3.3 Image Display

3.3.1 Mode

Step 1 Go to **Setting > Quick Start > Display**, choose **Edit Settings** Click **Mode** tag on Display Settings interface, the Mode page is displayed, as shown in figure.

Figure 3-3 Mode page

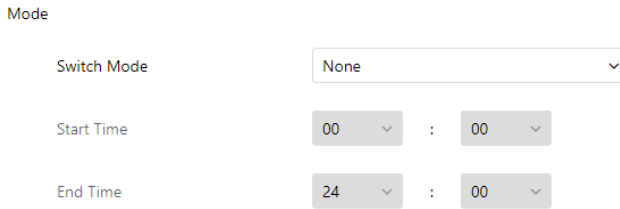

Step 2 Set the Mode parameters.

Step 3 Click **APPLY** to save the setting.

---End

3.3.2 Image

Figure shows the image interface.

Figure 3-4 Image interface



Table describes the image setting parameters.

Table 3-3 Image setting parameter description

Parameter	Description	Setting
Brightness	It indicates the total brightness of an image. As the value increases, the image becomes brighter.	[Setting method] Drag the slider. [Default value] 50
Detail Enhancement	Adjust the details and edges of higher temperature image.	[Setting method] Drag the slider. [Default value] 50

Parameter	Description	Setting
Contrast	It indicates the contrast between the bright part and the dark part of an image. As the value increases, the contrast increases.	[Setting method] Drag the slider. [Default value] 50
Sharpness	It indicates the sharpness of the image plane and the sharpness of the image edge. The clearer image, the better detail contrast.	[Setting method] Drag the slider. [Default value] 50

---End

3.3.3 Scene

Figure 3-5 shows the scene interface.

Figure 3-5 Scene interface

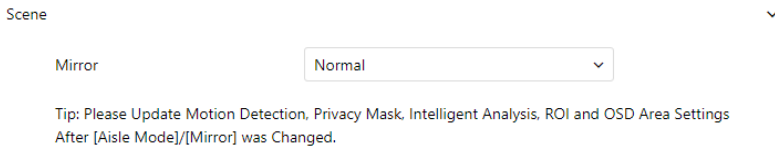

Provide the selection of image pixel locations.

Normal: the image is not flipped.

Horizontal: the image is flipped left and right.

Vertical: the image is flipped up and down.

Horizontal + Vertical: the image upside-down and reversal.

3.3.4 Set Pseudocolor

Figure 3-6 shows the Set Pseudocolor interface.

Figure 3-6 Set Pseudocolor interface



Table 3-4 Pseudocolor parameter

Parameter	Description	Setting
Pseudo-Colors	<p>Polarity/LUT: the temperatures of the temperature fields detected by the thermal imaging camera are separately mapped to values ranging from 0 to 255 by the algorithm. In the black/white display mode, this range is converted to the grayscale tones. For example, 0 indicates completely black, and 255 indicates completely white. The temperature field of the scene is converted to images by using the grayscale ranging from 0 to 255. Different polarity modes can be converted to different display images. The most common setting is white hot (a hotter object is displayed brighter than a colder object) or black hot (a hotter object is displayed darker than a colder object). The difference between two modes lies in that the temperatures corresponding to the darker one and the lighter one is reversed. Other modes include rainbow, ironbow, HSV, autumn, bone and so on.</p>	<p>[How to set] Select from the drop-down list box. [Default value] White Hot</p>
Legend of Temperature Value	<p>It is on, the live video will show, otherwise there is no legend.</p>	<p>[How to set] Select from the drop-down list box. [Default value] Close</p>

3.3.5 FFC Control

Figure shows the FFC interface.

Figure 3-7 FFC interface

FFC Control ▼

FFC Mode

FFC Interval(min) +

Temp deviation(0.1°C) +

Shutter Correction

Background Correction

Table describes the FFC mode parameters.

Table 3-5 FFC control parameter description

Parameter	Description	Setting
FFC Mode	The internal of the thermal imaging camera may comprise the mechanical action correction mechanism that can periodically improve the image quality. This component is called flat field correction (FFC). When controlling the FFC, the FFC shields the sensor array, so that each portion of the sensor can collect uniform temperature fields (flat field). By means of FFC, the camera can update the correction coefficients to output more uniform images. Throughout the FFC process, the video image is frozen for two seconds and a static-frame image is displayed. After the FFC is complete, the image is automatically recovered. Repeated FFC operations can prevent the grainy and image degradation problems. The FFC is especially important when the temperature of the camera changes. For example, after the camera is powered on or the ambient temperature is changed, you should immediately perform the FFC.	[How to set] Select from the drop-down list box. [Default value] Auto

Parameter	Description	Setting
	<p>Auto: In the Automatic FFC mode, the camera performs FFC whenever its temperature changes by a specified amount or at the end of a specified period of time (whichever comes first). When this mode is selected, the FFC interval (minutes) ranges from 5 to 30 minutes. The temperature change of the camera is based on the temperatures collected by the internal temperature probe. The temperature of the camera sharply changes when the camera is powered on. The FFC is relatively frequent, which is normal.</p> <p>Manual: In the manual FFC mode, the camera does not automatically perform the FFC based on the temperature change or the specified period. You can press the Do FFC button to select the manual FFC mode. When you feel that the image is obviously degraded but the automatic FFC is not performed, you can use the manual FFC function to check whether the image quality can be improved.</p>	
FFC Interval (min)	In the automatic FFC mode, the FFC interval ranges from 2 to 255 minutes.	[How to set] Drag the slider. [Default value] 5
Temper deviation(0.1℃)	In the automatic FFC mode, the FFC interval ranges from 0.2 to 25.5 centigrade.	[How to set] Drag the slider. [Default value] 5
Shutter Correction	Click the icon to adjust exposure immediately.	Click the button
Background Correction	Click the icon and cover the camera with something to adjust image. Remove the thing to finish adjustment.	Click the button

---End

3.3.6 Noise Reduction

Figure shows the Noise Reduction interface.

Figure 3-8 Noise reduction interface

The screenshot shows the 'Noise Reduction' settings interface. It features two sections: '2D NR' and '3D NR'. Each section has a checked checkbox, a dropdown menu set to 'Auto', and a 'Max Strength' slider. The sliders are currently positioned at the 50 mark, which is also displayed in a small input box to the right of each slider. The interface is clean and modern, with a light gray background and blue accents for the checkboxes and sliders.

Table describes noise reduction parameters.

Table 3-6 DNR parameter description

Parameter	Description	Setting
2 DNR	Decrease the image noise.	[How to set] Select from the drop-down list box. Drag the slider to adjust max strength. [Default value] Auto
3 DNR	Decrease the image noise.	[How to set] Select from the drop-down list box. Drag the slider to adjust max strength. [Default value] Auto

----End

3.3.7 Image Enhancement

Choose **Setting > Quick Start > Display > Image Enhancement** tag on display interface, the figure shows the enhance image interface

DeFog: It provides a clearer view of an image in the fogged environment when DeFog is enabled. As the value increases, the image becomes clearer. Tick the Defog mode and drag the slider.

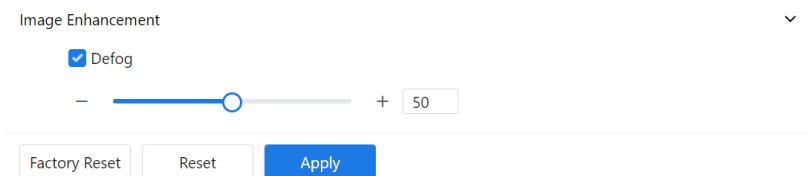



Image Enhancement ▼

Defog

—  + 50

Factory Reset Reset Apply



NOTE

All image settings can be modified at edit settings.

Factory Reset: All parameters will be restore to the factory settings.

Reset: the settings will be recovered to the last settings.

3.4 OSD

Description

The on-screen display (OSD) function allows you to display the device name, channel ID and name, time, and other customized contents on videos. You can drag the OSD frames to anywhere you want to put.

When the resolution is D1 and CIF, the OSD customized in web interface can show at most 22 words normally.

The OSD support simplified Chinese, English, digital and some special character only.

Procedure

Step 1 Choose **Setting > Quick Start > OSD**.

The **OSD** page is displayed, as shown in 4.3 Step 4.

Figure 3-9 OSD

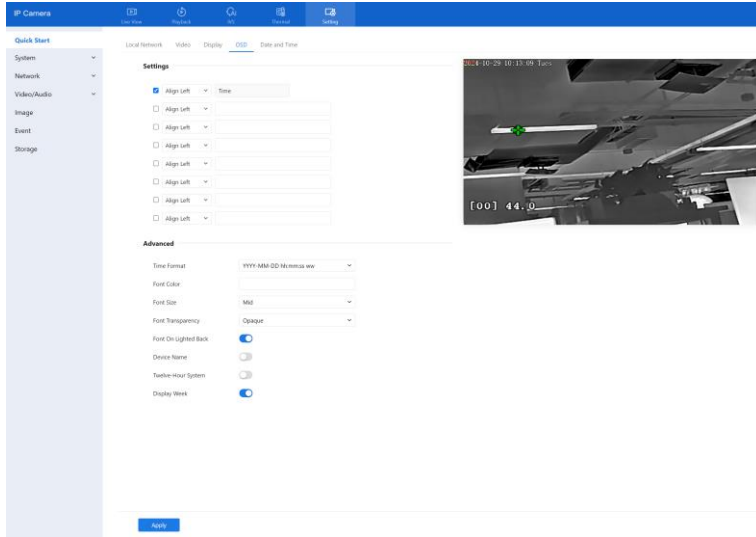

Step 2 Set the parameters according to Table 3-7.



NOTE

There are no more than seven OSD display areas.

Table 3-7 Parameters of OSD

Parameter	Description	Setting
Time	Indicates whether to display the time.	[Setting method] Tick the time.
Custom OSD	Tick to enable, choose the position to show content of custom OSD.	[Setting method] Enter the characters.
Time Format	Format in which the time is displayed.	[Setting method] Select a value from the drop-down list box. [Default value] YYYY-MM-DD hh:mm:ss ww

Parameter	Description	Setting
Font Color	Set the font color.	[Setting method] Select a value from the drop-down list box. [Default value] Blank
Font Size	Set the font size.	[Setting method] Select a value from the drop-down list box. [Default value] Mid
Font Transparency	Set the font transparency.	[Setting method] Select a value from the drop-down list box. [Default value] Opaque
Font on Lighted Back	Enable the font on lighted back.	[Setting method] Click the button on to enable Font on lighted back .
Device Name	Indicates whether to display the device name.	[Setting method] Click the button on to enable Device Name
Twelve-hour System	The time format shows at twelve-hour system.	[Setting method] Click the button on to enable
Display Week	The week will show.	[Setting method] Click the button on to enable

Step 3 Click **Advanced**, set the parameter of “Time Format”, “Font Color”, “Font Transparency”, “Font on lighted back”, and so on.

Step 4 Click **Apply**. The message "Apply success!" is displayed and the system will save the settings.

---End

3.5 Date and Time

Description

On the **Date and Time** page, you can modify the date and time. Parameters that can be set include:

Time zone and daylight-saving time (DST)

Date and time

Network Time Protocol (NTP) server

Procedure

Choose **Setting > Quick Start > Date and Time**.

The **Date and Time** page is displayed, as shown in Figure 3-10. Table 3-8 describes the parameters.

Figure 3-10 Date and time page

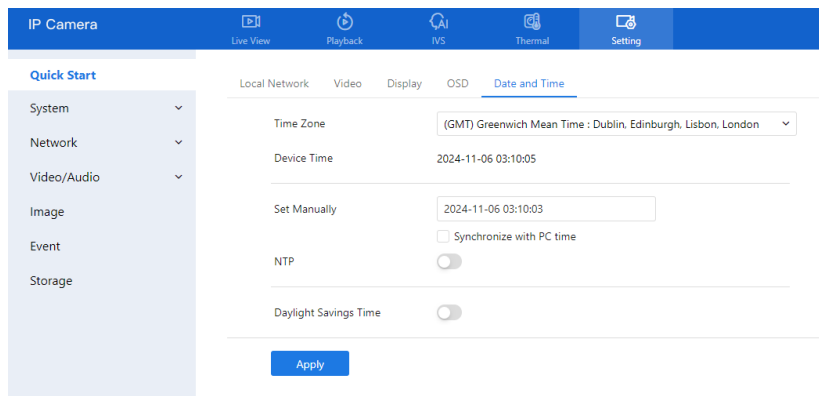

Table 3-8 Parameters of date and time

Parameter	Description	Setting
Time Zone	N/A	[Setting method] Select a value from the drop-down list box. [Default value] Greenwich mean time
Device Time	Device display time.	[Setting method]

Parameter	Description	Setting
		Synchronize the time from the PC. Enter a value manually.
Set Manually	You can set the device time manually or synchronize with PC time.	[Setting method] Click Set Manually and set the date and time in the format <i>YYYY-MM-DD HH:MM: SS</i> .
NTP	IP address or domain name of the NTP server.	[Setting method] Click the button on to enable NTP and enter a value manually.
Server Address	NTP is enabled. The NTP server IP.	[Setting method] Enter a value manually.
Port	NTP is enabled. Port number of the NTP server.	[Setting method] Enter a value manually. [Default value] 123
Interval	NTP is enabled. Set time interval to check if the device time has synchronized with the NTP server time.	[Setting method] Enter a value manually. [Default value] 60
Daylight Savings Time	When the DST start time arrives, the device time will automatically be one hour earlier. When the DST end time arrives, the device time will automatically be one hour later.	[Setting method] Click the button on to enable Daylight Saving Time .

Click **Apply**. The message "Apply success!" is displayed and the system will save the settings.

---End

4 Configuring Thermal

4.1 Settings

4.1.1 Temperature Parameters

Temperature parameters include temperature unit, ambient type, ambient temperature, cavity temperature, correctional coefficient, area temperature display mode, area temperature type, measure mode, area alarm interval and so on.

Operation Procedure

Step 1 Choose **Thermal > Settings > Temperature Parameter**.

The **Temperature Parameters** page is displayed, as shown in Figure 4-1.

Figure 4-1 Temperature Parameters Interface

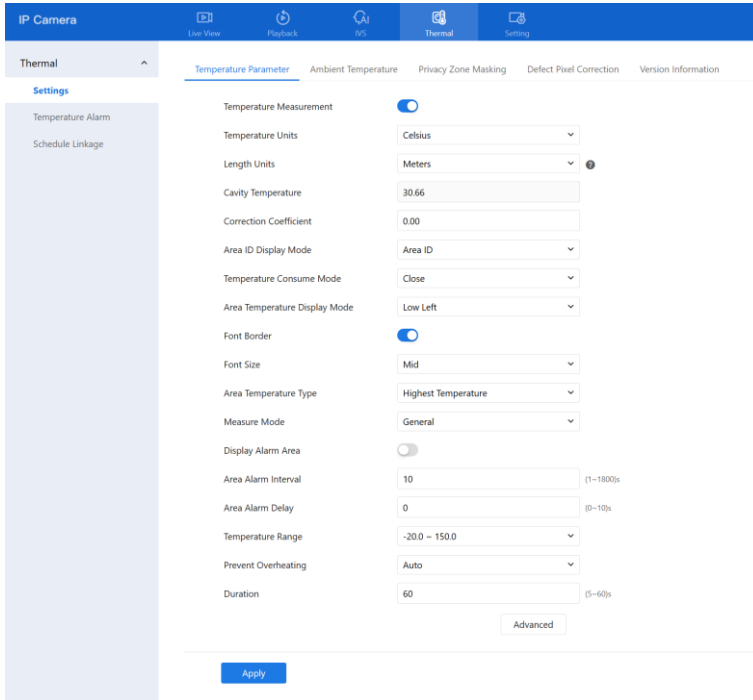

Step 2 Set the parameters according to Table 4-1.

Table 4-1 Temperature Parameters

Parameter	Description	Setting
Temperature Measurement	The default is enabling.	[Setting method] Enable or disable [Default value] Enable
Temperature Units	Celsius and Fahrenheit temperature units are available.	[Setting method] Select a value from the drop-down list box. [Default value] Celsius

Parameter	Description	Setting
Length units	Meters and feet length units are available.	[Setting method] Select a value from the drop-down list box. [Default value] Meters
Cavity Temperature	The cavity temperature of camera.	N/A
Correction Coefficient	Correction coefficient is refer to the deviation of measured object temperature and actual temperature, is offset value. It ranges from -100 to 100. For example: 1. The measured object temperature is 20, and actual temperature is 20.5, so the correction coefficient should be 0.5 . 2. The measured object temperature is 20, and actual temperature is 19.5, so the correction coefficient should be -0.5. NOTE User should contact the technical support staff of our company at this condition to make sure to apply	[Setting method] Enter a value manually. [Default value] 0.00
Area ID display mode	There two mode to display, area ID and area name	[Setting method] Select a value from the drop-down list box. [Default value] Area ID
Temperature Consume Mode	Transmission of temperature values or picture to third party platforms via Modbus protocol. This can be done via RS485/RS232/Ethernet. There three modes can be chosen, close/ jpeg +temperature/ temperature	[Setting method] Select a value from the drop-down list box. [Default value] Close

Parameter	Description	Setting
Area Temperature Display Mode	The display position of temperature information on the live-video image.	[Setting method] Select a value from the drop-down list box. [Default value] Low left
Font Border	Enable to bold the font	[Setting method] Enable or disable [Default value] Disable
Font size	There are three font sizes that can be chosen, small/mid/big	[Setting method] Enable or disable [Default value] Mid
Area Temperature Type	There are three types of area temperature.	[Setting method] Select a value from the drop-down list box. [Default value] Highest Temperature
Measure Mode	There are two types of measure modes.	[Setting method] Select a value from the drop-down list box. [Default value] General
Display Alarm Area	Tick, the setting alarm area will display on live video.	[Setting method] Enable or disable [Default value] Disable
Area Alarm Interval	During the interval, the same alarm will only be sent once.	[Setting method] Enter a value manually ranges from 1 to 1800s. [Default value] 10

Parameter	Description	Setting
Area Alarm delay (0-10S)	The area alarm information will delay for setting time.	[Setting method] Enter a value manually ranges from 1 to 10. [Default value] 10
Temperature range	It depends on the device. Different devices have different modes, such as -20 °C -150°C.	[Setting method] Select a value from the drop-down list box.
Prevent Overheating	Open, if temperature of the testing area is too high, you can enable it to prevent over heat function. The control cover will be lay down to keep the detector safe. There are two types, manual and auto.	[Setting method] Select a value from the drop-down list box.
Duration	Prevent over heat' mode is auto, the control cover will block for duration time automatically if over heat.	[Setting method] Enter a value manually ranges from 5 to 60s.

Figure 4-2 Advanced Interface

Dimming Mode Auto

Greater Prominent

Section Prominent

Less Prominent

Raw Data Upload Interval(F/S) 1

Mix Stream Mode Close

Table 4-2 Advance Parameters

Parameter	Description	Setting
Dimming Mode	There are auto and manual modes. Auto: It will show on temperature item depending on the full screen temperature. Manual: it will show on the manual value.	[Setting method] Select a value from the drop-down list box. [Default value] Auto
Greater Prominent	Enable that, the image will show the setting color if the temperature is higher than set value.	[Setting method] Enter a value manually. Choose one color to show.
Section Prominent	Enable that, the image will show the setting color if the temperature is between minimum and maximum temperature.	[Setting method] Enter a value manually. Choose one color to show.
Less Prominent	Enable that, the image will show the setting color if the temperature is lower than set value.	[Setting method] Enter a value manually. Choose one color to show.
Raw Data Upload Interval(F/S)	Interval of uploading the raw data.	[Setting method] Select a value from the drop-down list box. [Default value] 1
Mix Stream Mode	This function is used for mixing thermal and visible imaging, if you want to adjust the location, please set at thermal channel “ Setting > Display > Pseudocolor” tab interface. There are close, mode 1 mode 2, and mode 3. The different models maybe have different displays; Please refer to the actual product.	[Default value] Close

Click **Apply** to save.

---**End**

4.1.2 Ambient Temperature

Choose **Thermal > Settings > Ambient Temperature**

Figure 4-3 Ambient Temperature

Table 4-3 Parameter of Ambient Temperature

Parameter	Description	Setting
Ambient Temperature	Environment temperature of camera. When the camera is power on for at least half an hour and the cavity temperature is stabilize , set the temperature. It is set as environment temperature of camera.	[Setting method] Enter the temperature of ambient environment. [Default value] 25
Self-adaptive Temperature	Set the ambient temperature, click “Apply”, the camera will get the value automatically.	---

Click **Apply** to save.

---End

4.1.3 Privacy Zone Masking

Privacy zone masking is meaning that the camera will do not detect the temperature of that area. The shield areas can be set up to eight areas.

Operation Procedure

Step 1 Choose **Thermal > Settings > Privacy Zone Masking**.

Figure 4-4 Privacy Zone Masking

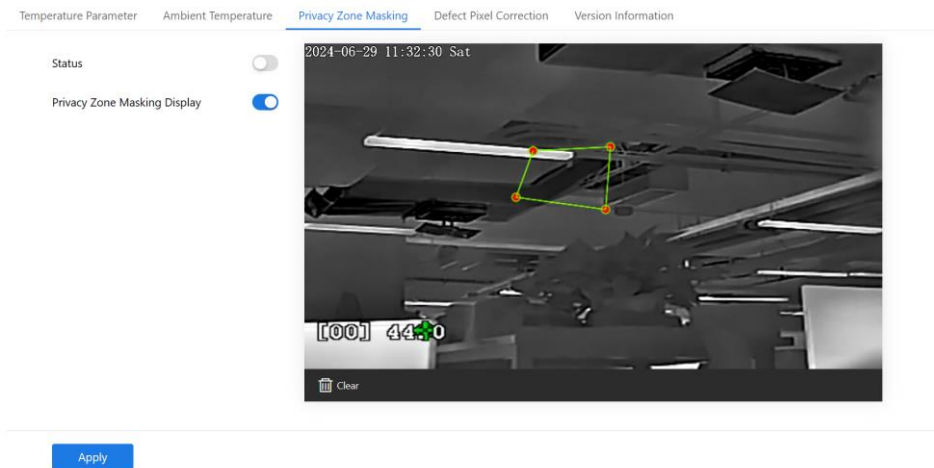

Step 2 Enable the privacy zone masking.

Step 3 Enable Show Privacy Zone Masking Display, then the setting shield will show on live video.

Step 4 Click-left mouse button to set area; Click-right mouse button to end the setting.

Step 5 Click **Clear** to clear the setting area.

Step 6 Click **Apply** to save.

----End

4.1.4 Defect Pixel Correction

Operation Procedure

Step 1 Choose **Thermal > Settings > Defect Pixel Correction**.

The **Defect Pixel Correction** page is displayed, as shown in figure.

If the image has a white dot as shown in figure, user can test the function to recover the defect pixel. Users should connect the technical support at this condition to make sure to apply.

Figure 4-5 Defect pixel correction

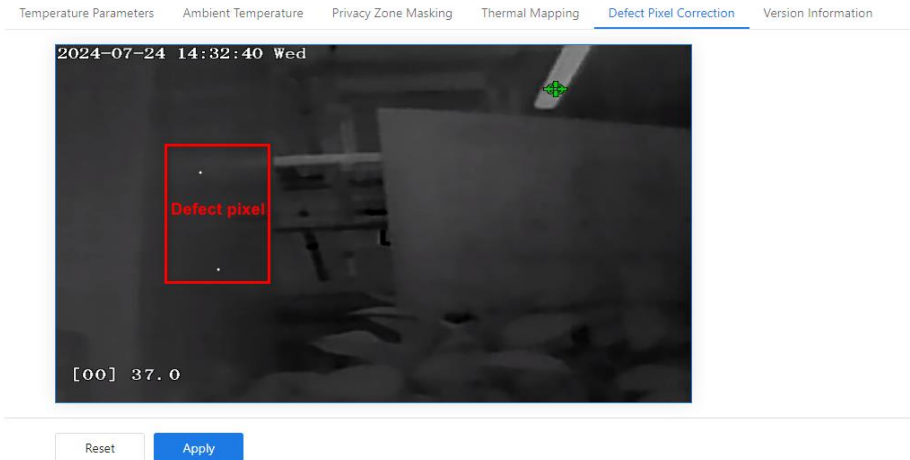

Step 2 Click the white point at image, click **Reset** to recover the defect pixel, as shown in Figure 4-6.

Figure 4-6 Recover Defect Pixel



Step 3 Click **Apply**. The message "Apply success" is displayed, the system will save the settings.

----End

4.1.5 Version Information

Check the MCU version and MCU sequence number for easy traceability

4.2 Temperature Alarm

Operation Procedure

Step 1 Choose **Thermal > Temperature Alarm**.

The **Temperature Alarm** page is displayed, as shown in Figure 4-7.

Figure 4-7 Temperature Area and Alarm Configuration

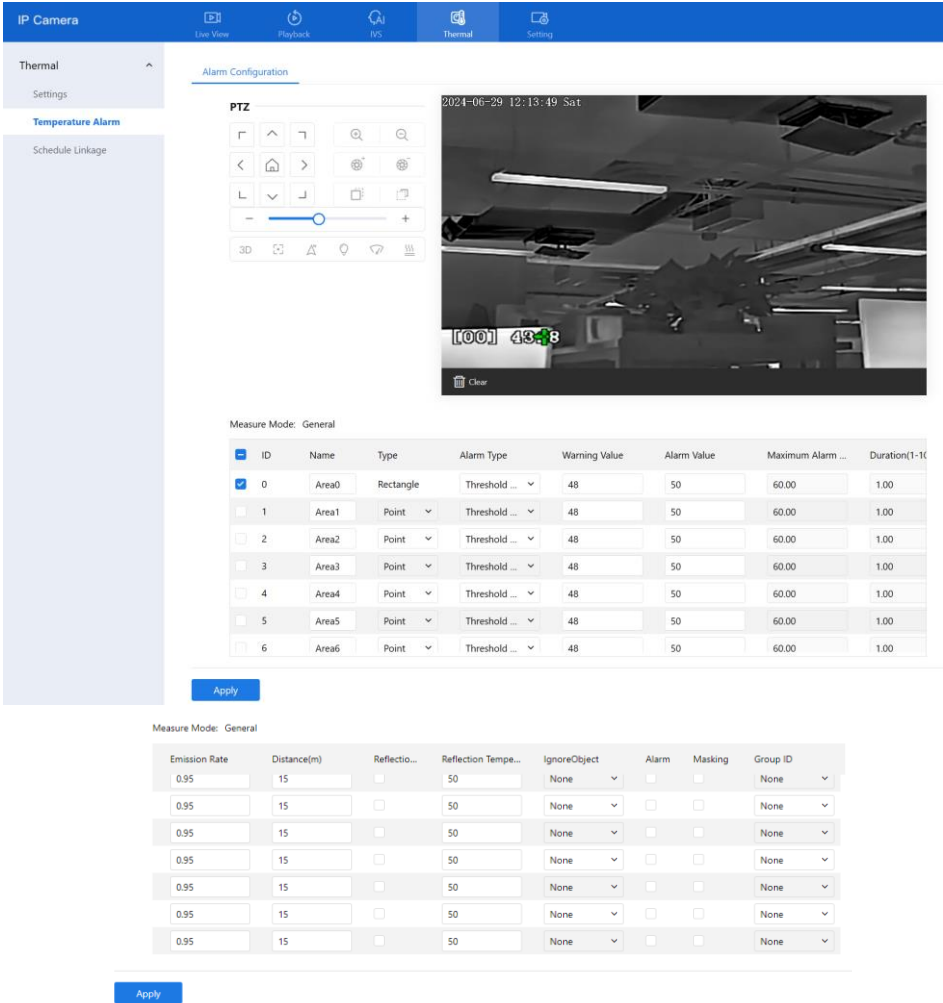

Step 2 Set the parameters according to Table 4-4.

Table 4-4 Alarm configuration

Parameter	Description	Setting
Measure Mode	Set at temperature parameter interface.	N/A
Enable	Tick the ID to enable the area measuring.	[Setting method] Tick

Parameter	Description	Setting
Name	Area name of temperature area.	[Setting method] Enter a value manually.
Type	Type of temperature area. ID 0 is default rectangle area, which is full screen. It cannot be modified. Other IDs can be set as point, line, or polygon.	[Setting method] Select a value from the drop-down list box. [Default value] Rectangle/Point
Alarm Type	Temperature difference alarm: when the area's temperature difference (Highest temperature minus Average temperature) is over the setting value (Warning temperature or Alarm temperature), it will generate the alarm. Temperature rise alarm: In the duration time. If the rising temperature value is more than the set value (Warning temperature or Alarm temperature), it will generate the alarm. Temperature threshold alarm: when the temperature is higher than threshold, the alarm will be triggered. Section Alarm: if the temperature value is among the set temperature range, it will generate the alarm.	[Setting method] Select a value from the drop-down list box. [Default value] Threshold alarm
Warning Value	Camera will trigger warning alarm when the object temperature reaches the warning value.	[Setting method] Enter a value manually. [Default value] 48
Alarm Value	Camera will alarm when the object temperature reaches the alarm value.	[Setting method] Enter a value manually. [Default value] 50

Parameter	Description	Setting
Maximum Alarm Value	At section alarm type, the device would not alarm when the temperature is higher than maximum alarm value.	[Setting method] Enter a value manually. [Default value] 60.00
Duration (1-10S)	Choose temperature rise alarm, set the duration. the temperature value rises within duration setting, the alarm is triggered successfully.	[Setting method] Enter a value manually. [Default value] 1.00
Emission Rate	The emission rate is the capability of an object to emit or absorb energy. The emission rate should be set only when the target is special material.	[Setting method] Enter a value manually. [Default value] 0.95
Distance(m)	The distance between camera and target.	[Setting method] Enter a value manually. [Default value] 15  NOTE Enter actual distance when the distance between camera and target is less than 15m. Enter 15 when the distance between camera and target is great than or equal to 15m.
Reflection Temperature on	When there are some high temperature objects on scene, and the temperature reflect to the other object, you can enable this function to calibrate the temperature.	[Setting method] Tick to enable
Reflection Temperature	The temperature of high temperature object.	[Setting method] Enter a value manually. [Default value] 50.00

Parameter	Description	Setting
Ignore Object	Enable to shield the temperature of area capturing AI object.	[Setting method] Select a value from the drop-down list box.
Alarm	Enable or disable the alarm output and linkage of area.	[Setting method] Tick to enable alarm.
Masking	Enable, the device will shield this area's temperature.	[Setting method] Tick to shield.
Group ID	<p>Different areas can be divided into the same group. The same group's areas will be merger calculated temperature difference alarm.</p> <p>The ID can be chosen into one of six groups, or no group. The group will be alarm following as the next rules:</p> <p>A=The highest temperature of groups (the highest temperature of N regions is the largest)</p> <p>B=Average temperature of groups (average temperature of N regions)</p> <p>WA=Warning value</p> <p>AA=Alarm value</p> <p>a. If $A-B \geq WA$, a temperature difference warning signal is generated ---> (the one with the largest difference between the N areas and the average temperature is the alarm area flashing)</p> <p>b. If $A-B \geq AA$, a temperature difference alarm signal is generated --> (the one with the largest difference between the N areas and the average temperature is the alarm area flashing)</p> <p>c. If the warning and alarm conditions are met at the same time, the alarm signal will be generated first.</p>	[Setting method] Select a value from the drop-down list box.

Step 3 Set temperature area.

1. Tick an area ID. Set the name.
2. Choose the type (point, line, polygon)

- Press and hold the left mouse button, and drag in the video area to draw a temperature area, as shown in Figure 4-8. Right-click to finish the area selected.

Figure 4-8 Temperature Area Setting Interface



Step 4 Click **Apply**, the message “Apply success” is displayed, the temperature area is set successfully.

NOTE

ID 0 is the full screen; The area cannot be changed.



: The lowest temperature of the full screen.



: The highest temperature of the full screen.



: The lowest temperature of the area.



: The highest temperature of the area.

Step 5 Delete a temperature area:

- Select an area ID.
- Click **Clear**.
- Remove the tick of area ID.
- Click **Apply**, the message “Apply success” is displayed, the temperature area is deleted successfully.

Step 6 Click **Apply**. The message "Apply success" is displayed, the system will save the settings.

---End

4.3 Schedule Linkage

Operation Procedure

Step 1 Choose Thermal > Schedule Linkage.

There are seven type alarm linkage, threshold alarm, threshold warning, temperature difference alarm, temperature difference warning, temperature section alarm, temperature rise alarm, temperature rise warning.

The **Schedule Linkage** page is displayed, as shown in Figure 4-9.

Figure 4-9 Schedule Linkage

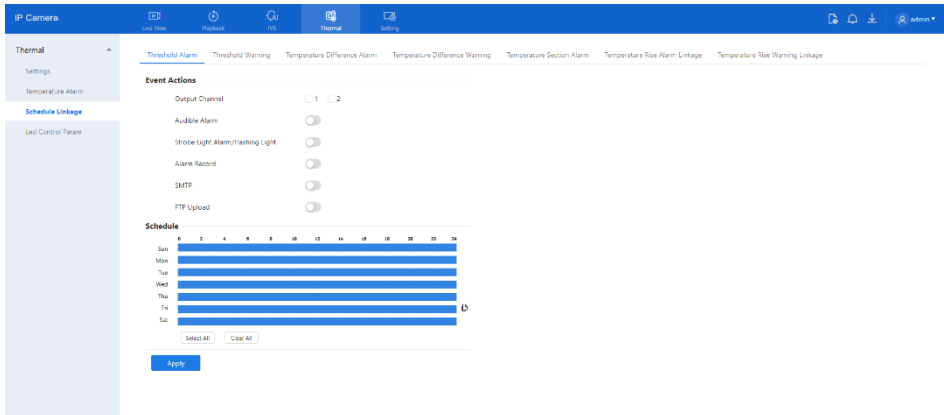

Step 2 Tick the output channel.

Step 3 Enable wanted linkage: “Output Channel” “Audible alarm”, “Alarm Record”, “SMTP”, “FTP upload”,..

Step 4 Set schedule linkage.

Method 1: Hold down the left mouse button, drag and release mouse to select the deployment time within 0:00-24:00 from Monday to Sunday.

Method 2: Click **Select All** to deploy all time.

Method 3: set one day, click  to copy to other days.

Figure 4-10 Copy

Copy:

- All
- Sun
- Mon
- Tue
- Wed
- Thu
- Fri
- Sat

OK

Delete schedule time: click **Clear All** to delete all time.

08:30 ~ 10:00 **OK** **Delete**

Click the set time, delete this time. click **Delete** to

Step 5 The message "Apply success" is displayed, the system will save the settings.

 **NOTE**

Figure 4-11 Audio file

ID	File Name	Cycle Number	Operate
1	high_temperature_alarm.wav	1	< > ⬆️ ⬆️
2	normal_temperature.wav	1	< > ⬆️ ⬆️
3	low_temperature_alarm.wav	1	< > ⬆️ ⬆️
4	hello_welcome.wav	1	< > ⬆️ ⬆️
5	verification_success.wav	1	< > ⬆️ ⬆️
6	verification_failed.wav	1	< > ⬆️ ⬆️
7	temperature_rise_warning.wav	1	< > ⬆️ ⬆️
8	temperature_rise_alarm.wav	1	< > ⬆️ ⬆️
9	temperature_range_alarm.wav	1	< > ⬆️ ⬆️
10	temperature_diff_alarm.wav	1	< > ⬆️ ⬆️

User can set the audio file manually. Click  to upload the audio file(The type should be WAV, size must be less than 250 Kb, the bit rate should be 128 kbps.), as shown in Figure 4-12.

Figure 4-12 Upload audio file

----End

5 IVS Settings

At IVS (intelligent video system) page, users can set deep learning (**AI multi-target**), intelligent analysis (**intrusion, smart motion, single line crossing, double line crossing, multi-loitering, wrong-way, enter area, leave area**), environmental safety analysis (**smoking, fire spot detection**), behavior analysis (**people counting**).

5.1 AI Multi-Target

Step 1 At “IVS > AI Multi-Target” interface, user can enable full-body detection, vehicle detection to detect the person and vehicle, as shown in Figure 5-1.

Figure 5-1 AI Multi-Target

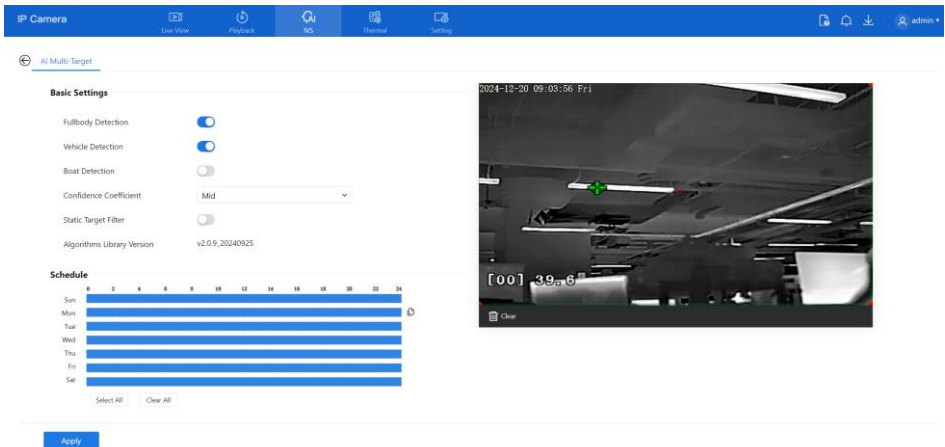

Step 2 Set the parameters of AI Multi-Target following as the Table 5-1 .

Table 5-1 AI Multi-Target parameters

Parameter	Description	How to set
Full body detection	The camera will snap the whole body when someone appear in live video. The detection frame is blue.	Enable
Vehicle detection	The camera will snap the licence when the vehicle appear in live video. The detection frame is yellow.	Enable
Boat detection	The camera will snap the whole body when someone appear in live video. The detection frame	Enable

	is light blue.	
Confidence Coefficient	The range of snapshots, there are three type, such as high, mid and low. The higher the confidence, the better the snap quality and the fewer snapshots.	Choose from drop list.
Static Target Filter	If the target is static, the device will filter this target. For example, if a vehicle stop for long time, the device will be filtered.	Enable

Step 3 Draw the detection area by using the mouse.

Step 4 Set the schedule, please refer to chapter 4.3 Step 4.

Step 5 click “Apply” to save the settings.

---End

5.2 Intelligent Analysis

5.2.1 Intrusion

The Intrusion function refers to that an alarm is generated when target objects (such as person, vehicle, and both person and vehicle) enter the deployment area.

Procedure

Step 1 Select **IVS > Intelligent Analysis > Intrusion** to access the **Intrusion** interface, as shown in Figure 5-2.

Figure 5-2 Intrusion Setting Interface

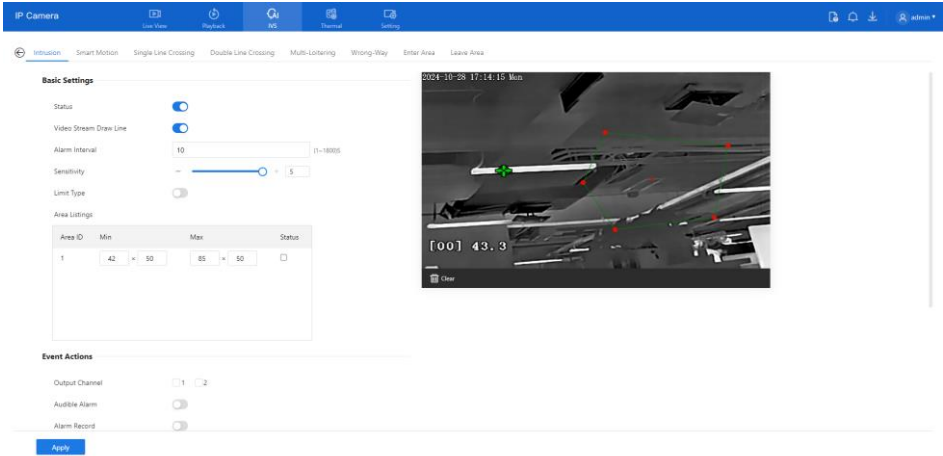

Step 2 Set all parameters of Intrusion. Table 5-2 describes the specific parameters.

Table 5-2 Intrusion Parameter Description

Parameter	Description	Setting
Status	Enable the button to enable the alarm.	[How to set] Click Enable to enable. [Default value] OFF
Video Stream Draw Line	Enable the button, the draw frame of detection will show at live video.	[How to set] Click to enable FTP Upload. [Default value] OFF
Alarm Interval	During the interval, the same alarm will only be sent once.	[How to set] Input a value [Default value] 10
Sensitivity	The sensitivity of detecting smoking, when the value is high, the alarm can be triggered easily, but the accuracy will be lower.	[How to set] Choose from the drop-down list [Default value] 5

Parameter	Description	Setting
Limit Type	Effective alarms are set based on target type, with options of Person or Vehicle, person, vehicle. When the device is used indoors, because of small space and large targets, to avoid wrong alarms are triggered b person even if vehicle is selected, it is recommended to set the target type to person for indoor use.	[How to set] Click to enable Limit Target Type. [Default value] OFF
Area listings	When users set the areas, the area will show on listing. If the area status is on, the min and mix size will show on area, drag the frame to move, adjust the points of frame to change size.	
Output Channel	If you check to set the Output Channel and the device is connected to an external alarm indicator, the alarm indicator signals when an alarm is triggered.	[How to set] Click to select an ID.
Audible alarm	After enabling Audible Warning and setting Audible Alarm Output, the built-in speaker of the device or connected external speaker plays warning sounds when an alarm happens. (set at the “ Setting > Video / Audio > Audio File ”)	[How to set] Click to enable Audible alarm [Default value] OFF
SMTP	Enable the button to enable SMTP server.	[How to set] Click to enable SMTP. [Default value] OFF
FTP Upload	Enable the button to enable File Transfer Protocol.	[How to set] Click to enable FTP Upload. [Default value] OFF

Step 3 Set a deployment area. Move the cursor to the drawing interface and click to generate a point, move the cursor to draw a line, and then click to generate another point. This is how a line is generated. In this way, continue to draw lines to form any shape, and right-click to finish line drawing.

NOTE

A drawn line cannot cross another one, or the line drawing fails.

Any shape with 32 sides at most can be drawn.

The quantity of deployment areas is up to 8.

Step 4 Set deployment time, please refer to chapter 4.3 Step 4.

Step 5 Click **Apply** to save the settings.

----End

5.2.2 Smart Motion

Smart motion refers to the alert generated when a specified type of target (such as a person, vehicle, etc.) moves within the live video defense area.

Select **IVS > Intelligent Analysis > Smart Motion** to access the **Smart Motion** interface, as shown in .

Figure 5-3 Smart Motion

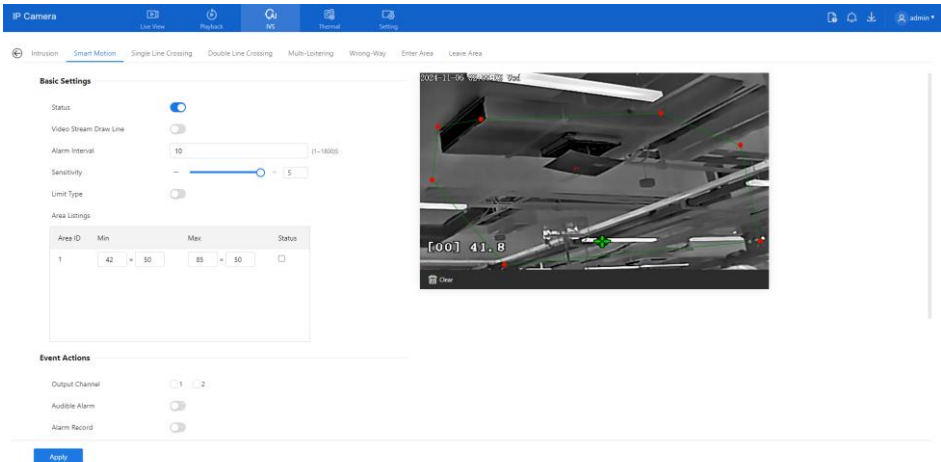

Set all parameters of smart motion, please refer to chapter 5.2.1

5.2.3 Single Line Crossing

A Single Line Crossing is a line that is set at a concerned position within the monitored field of view and specifies the forbidden travel direction; An alarm is generated when the targets of specified types (such as person or vehicle) cross this line.

Procedure

Step 1 Select **IVS > Intelligent Analysis > Single Line Crossing** to access the **Single Line Crossing** setting interface, as shown in Figure 5-4.

Figure 5-4 Single Line Crossing Setting Interface

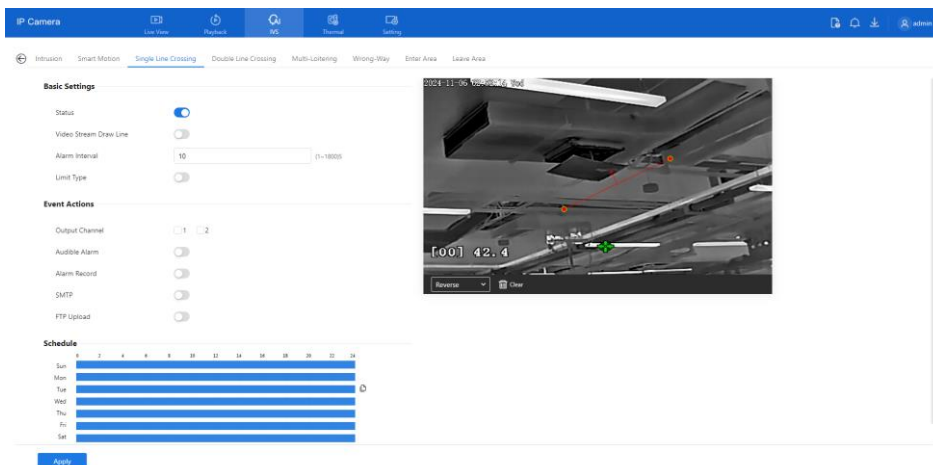

Step 2 Set all parameters of the Single Line Crossing, please refer to Table 5-2.

Step 3 Set a deployment area.

Draw a line: Move the cursor to the drawing interface, hold down the left mouse button, and move the cursor to draw a line. When you release the left mouse button, a Single Line Crossing is generated.

Setting a Single Line Crossing: Click a line (and the trip line turns red) to select the Single Line Crossing and set its direction as Positive, Reverse or Bidirectional, or delete the selected line. You can also press and hold left mouse button at the endpoint of a Single Line Crossing and move the mouse to modify the position and length of this Single Line Crossing. You can right-click to delete the Single Line Crossing.

Figure 5-5 Set Single Line Crossing line



NOTE

Try to draw the Single Line Crossing in the middle, because the recognition of a target takes time after target appearance on the screen and an alarm is generated only when the object is recognized to have crossed the Single Line Crossing.

The Single Line Crossing which detects person foot as the recognition target cannot be too short, because a short Single Line Crossing tends to miss targets.

Step 4 Set deployment time, please refer to chapter 4.3 Step 4.

Step 5 Click **Apply** to save the settings.

----End

5.2.4 Double Line Crossing

Double Line Crossing refers to two lines that are set at a concerned special position within the field of view and specify the forbidden travel direction. When the targets of specified types (such as person or vehicle) move along the set travel direction and cross these lines in a certain order (line 1 followed by line 2) in pass max time, an alarm is generated.

Procedure

Step 1 Select **IVS > Intelligent Analysis > Double Line Crossing** to access the **Double Line Crossing** setting interface, as shown in Figure 5-6.

Figure 5-6 Double Line Crossing Setting Interface

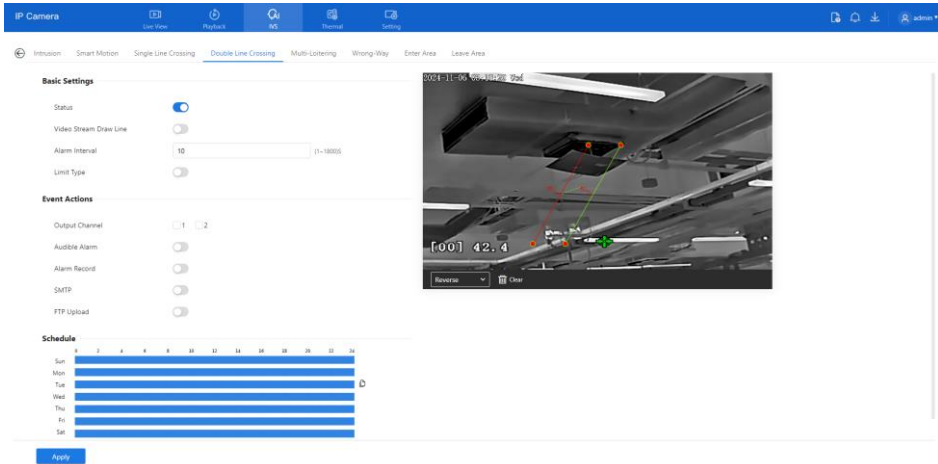

Step 2 Set all parameters of the Double Line Crossing. please refer to chapter 5.2.1

Step 3 Set a deployment area.

Draw a line: Move the cursor to the drawing interface, hold down the left mouse button, and move the cursor to draw two lines. When you release the left mouse button, two numbered virtual fences are generated. Choose either of the Double Line Crossing to set the direction to Positive or Reverse.

Set Double Line Crossing: Click one of the Double Line Crossing (and the virtual fence turns red) to select this virtual fence and set the direction to **Positive** or **Reverse**, or delete the selected line. You can also press and hold left mouse button at the endpoint of a virtual fence and move the mouse to modify the position and length of this virtual fence. You can right-click to delete the Double Line Crossing.

NOTE

The two lines are in sequential order. An alarm is generated only when a target crosses virtual fence 1 and then virtual fence 2 within the set maximum passing time.

Try to draw Double Line Crossing in the middle, because the recognition of a target takes time after target appearance on the screen and an alarm is generated only when the object is recognized to have crossed the Double Line Crossing.

The Double Line Crossing which detect person foot as the recognition target cannot be too short, because short Double Line Crossing tend to miss targets.

Step 4 Set deployment time, please refer to chapter 4.3 Step 4.

Step 5 Click **Apply** to save the settings.

----**End**

5.2.5 Multi-Loitering

Multi-Loitering allows setting the shortest loitering time for multiple targets of specified type (such as person or vehicle) within the deployment area in the field of view. When the loitering time of the multiple targets within this area meets the set shortest loitering time, an alarm is generated.

Select **IVS > Intelligent Analysis > Multi-Loitering** to access the **Multi-Loitering** setting interface, as shown in Figure 5-7.

Figure 5-7 Multi-Loitering

The screenshot displays the Multi-Loitering configuration interface. At the top, there are navigation tabs: IP Camera, Live View, Playback, IVS, Thermal, and Setting. Below these are sub-tabs: Intrusion, Smart Motion, Single Line Crossing, Double Line Crossing, Multi-Loitering (selected), Wrong-Way, Enter Area, and Leave Area.

Basic Settings

- Status:
- Video Stream Draw Line:
- Alarm Interval: 10 (range: 01-1000S)
- The Shortest Time: 10 (range: 05-600S)
- Limit Numbers:

Area Listings

Area ID	Min	Max	Status
1	42 × 50	85 × 50	<input type="checkbox"/>

Event Actions

- Output Channel: 1 2
- Audible Alarm:
- Alarm Record:
- SMTP:
- FTP Upload:

Schedule

A 24-hour bar chart shows the schedule for each day of the week (Sun, Mon, Tue, Wed, Thu, Fri, Sat). All days have a blue bar, indicating the Multi-Loitering function is active throughout the day. Below the chart are 'Select All' and 'Clear All' options.

An **Apply** button is located at the bottom of the configuration panel.

Set all parameters of multi-loitering please refer to chapter 5.2.1

5.2.6 Wrong -Way

Wrong-Way allows setting the travel direction criteria for a target within an area on the video screen.

Someone/something is moving towards the opposite direction in an area, an alarm is generated.

Select **IVS > Intelligent Analysis > Wrong-Way** to access the **Wrong-Way** setting interface, as shown in Figure 5-8.

Figure 5-8 Wrong-Way

Basic Settings

Status

Video Stream Draw Line

Alarm Interval (1-1800S)

Limit Type

Area Listings

Area ID	Min	Max	Status
1	42 × 50	85 × 50	<input type="checkbox"/>

Event Actions

Output Channel 1 2

Audible Alarm

Alarm Record

SMTP

FTP Upload

Schedule

Sun

Mon

Tue

Wed

Thu

Fri

Sat

Set all parameters of wrong-way please refer to *chapter 5.2.1*

5.2.7 Enter Area

The enter area refers to that an alarm is generated when a target enters the deployment area at the valid time.

Select **IVS > Intelligent Analysis > Enter Area** to access the **Enter Area** setting interface, as shown in Figure 5-9.

Figure 5-9 Enter Area

IP Camera Live View Playback IVS Thermal Setting

Intrusion Smart Motion Single Line Crossing Double Line Crossing Multi-Loitering Wrong-Way Enter Area Leave Area

Status

Video Stream Draw Line

Alarm Interval 10 (1-1800s)

Sensitivity

Limit Type

Area Listings

Area ID	Min	Max	Status
1	42	85	<input type="checkbox"/>

Event Actions

Output Channel 1 2

Audible Alarm

Alarm Record

SMTP

FTP Upload

Schedule

Sun

Mon

Tue

Wed

Thu

Fri

Sat

Select All Clear All

Apply

Set all parameters of entering area, please refer to chapter 5.2.1

5.2.8 Leave Area

The leave area refers to that an alarm is generated when a target leaves the deployment area at the valid time.

Select **IVS > Intelligent Analysis > Leave Area** to access the **Leave Area** setting interface, as shown in Figure 5-10.

Figure 5-10 Leave Area

Basic Settings

Status

Video Stream Draw Line

Alarm Interval (1-1800S)

Sensitivity

Limit Type

Area Listings

Area ID	Min	Max	Status
1	42	85	<input type="checkbox"/>

Event Actions

Output Channel 1 2

Audible Alarm

Audible Alarm File

Alarm Record

SMTP

FTP Upload

Schedule

Sun

Mon

Tue

Wed

Thu

Fri

Apply

Set all parameters of leaving area, please refer to chapter 5.2.1

5.3 Environmental Safety Analysis

At the advanced environmental Safety Analysis interface, users can set the parameters of smoking detection, smoke and flame detection, and fire spot detection. Enable the linkage actions, the alarm information can be sent to user by the linkage.

5.3.1 Smoking Detection

Description

The smoking detection function refers to that an alarm is generated when someone is smoking or generating spark at the deployment area.

Select **IVS > Environmental Analysis > Smoking Detection** to access the **Smoking Detection** interface, as shown in Figure 5-11.

Figure 5-11 Smoking detection interface

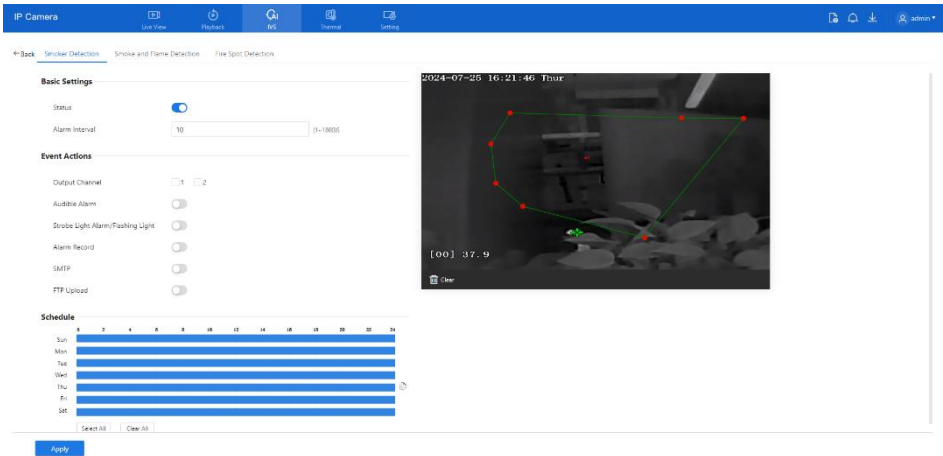

Set all parameters of smoking detection, please refer to chapter 5.2.1

----End

5.3.2 Fire Spot Detection

Description

The fire spot detection function refers to that an alarm is generated when something is on fire at the deployment area.

Procedure

Step 1 Select **IVS > Environmental Analysis > Fire Spot Detection** to access the **Fire Spot Detection** interface, as shown in Figure 5-12

Figure 5-12 Fire spot detection interface

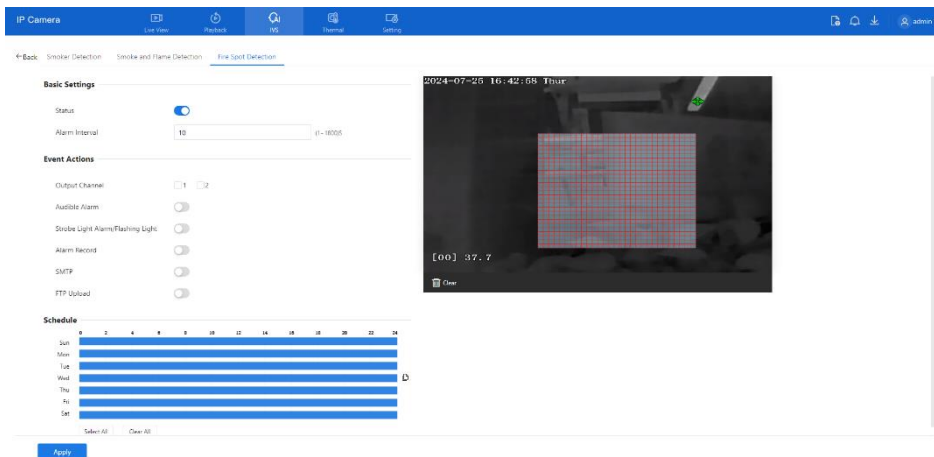

Step 2 Set all parameters of Fire Spot Detection, please chapter 5.2.1

Step 3 Set a deployment area.

Use mouse to draw rectangular area, you can set several area to deploy, as shown in Figure 5-13.

Figure 5-13 Set deployment area

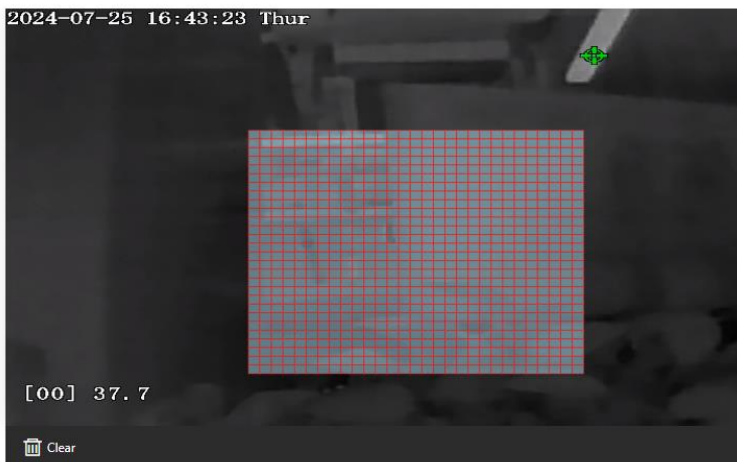

Step 4 Set deployment time, please refer to chapter 4.3 Step 4.

Step 5 Click **Apply** to save the settings.

---End

5.4 People Counting

Users can draw line to count the number of people in the special area.

5.4.1 Set

Procedure

Step 1 Select **IVS > People Counting > Set** to access the **People Counting** setting interface, as shown in Figure 5-14.

Figure 5-14 People counting

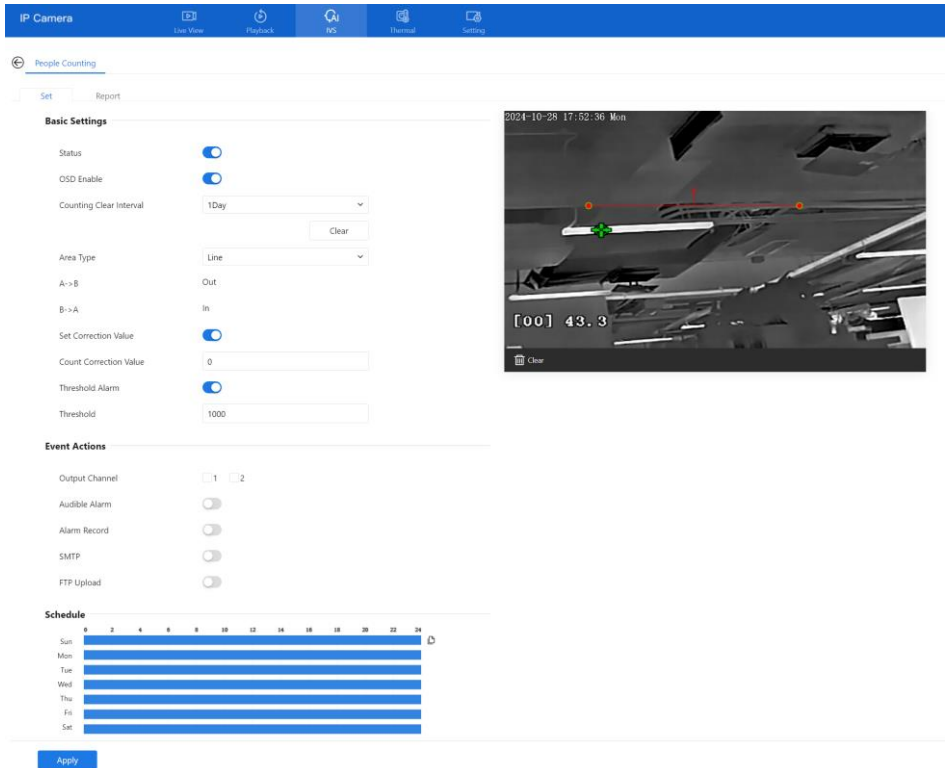

Step 2 Set all parameters of People Counting. Table 5-3 describes the specific parameters.

Table 5-3 Parameters of people counting

Parameter	Description	Setting
Status	Enable the button to enable the alarm.	[How to set] Click button to enable. [Default value] OFF
OSD Enable	Enable the OSD, the count data will show on live video screen.	[How to set] Click Enable to enable. [Default value] OFF
Counting Clear Interval	The camera will clear counting data at the setting interval. Click the “Clear Counting”, clearing the data immediately.	[How to set] Choose from drop-down list. [Default value] 1 Day
Area Type	Draw a line on live video screen. The label of A and B indicate out and in.	[How to set] Choose from drop-down list. [Default value] Line
Set Correction Value	Enable, set the count correction value, it can be positive or negative. For example, if there are 30 people enter the area before counting, input 30 to correct. If 30 people go out the area, input -30.	[How to set] Enable /Input a value in the area box. [Default value] 0
Threshold Alarm	Enable, when the counting number reaches the threshold value, an alarm is triggered.	[How to set] Click Enable to enable. [Default value] OFF
Threshold	The threshold of enable alarm.	[How to set] Enable /Input a value in the area box. [Default value] 1000
Output Channel	If you check to set the Output Channel and the device is connected to an external alarm indicator, the alarm indicator signals when an alarm is triggered.	[How to set] Click to select an ID.

Parameter	Description	Setting
Audible alarm	Enable, when an alarm occurs, it will play audio to alarm. Choose the audible alarm file (set at the “ Configuration > Alarm > Audible Alarm Output ”).	[How to set] Click to enable Audible alarm [Default value] OFF
SMTP	Enable the button to enable SMTP server. The parameters of SMTP can be set at Configuration > Network Service > SMTP interface.	[How to set] Click to enable SMTP. [Default value] OFF
FTP Upload	Enable the button to enable File Transfer Protocol. The parameters of FTP can be set at Configuration > Network Service > FTP interface.	[How to set] Click to enable FTP Upload. [Default value] OFF

Step 3 Set a deployment area.

Move the cursor to the drawing interface and click to generate a point, move the cursor to draw a line, and then click to generate another point. This is how a line is generated. In this way, continue to draw lines to form any shape, and right-click to finish line drawing.

Step 4 Set deployment time.

Step 5 Click **Apply** to save the settings

----**End**

5.4.2 Report

At people counting report interface, you can view the data of people counting through setting query condition (choose the detail time at date’s pop-up window). There are three modes to show the data, such as line chart, histogram, and list, as shown in Figure 5-15.

Figure 5-15 Report of people counting

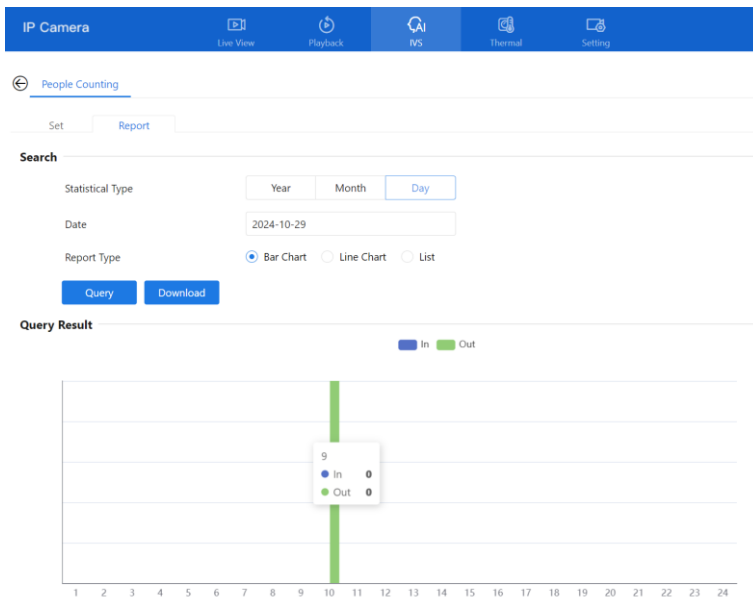

Click “Download” to download the query result.

Choose the mode of showing result, such as line chart, histogram and list.

Click “Query” to query the data of people counting.

The data result can be saved to local folder.

---End

A Troubleshooting

Common Trouble	Possible Cause	Solution
Unable to access the web	Network is not connected.	<p>Connect the network cable of the camera to the PC to check whether the network cable is in good contact.</p> <p>Run the ping command to check the network connection and whether the device works normally.</p>
	IP address is occupied.	Directly connect the camera to the PC, and reset the IP address of the camera.
	The IP addresses of the PC and the device are in different networks.	Check the IP address, subnet mask and gateway setting of the camera.
The measured temperature is not accurate.	The device is just powered on, and the temperature of the cavity is unstable.	The temperature of the cavity is stable within 15 to 30 minutes after the device is powered on.
	The FFC mode is incorrect.	The FFC default mode is automatic. If the mode is set to manual, it will be no block calibration, which may lead to fuzzy pictures and inaccurate temperature.
	The target configuration is incorrect.	Check whether the emission rate and distance of the target are configured correctly.
An error occurs in accessing the web of the device after the upgrade.	The data in the cache of browser is not updated in time.	<p>Delete the cache of browser. The steps are as follow:</p> <p>Press Ctrl + Shift + Delete, the pop-up window shows the Clear browsing data dialog box appears.</p> <p>Select all check boxes.</p> <p>Click Clear now.</p> <p>Relogin the web page of the camera.</p>
Upgrade failed.	<p>No network cable is connected.</p> <p>The network setting is incorrect.</p>	<p>Ensure the upgrade network is connected.</p> <p>Check whether the network setting is correct.</p>

Common Trouble	Possible Cause	Solution
	The upgrade package is incorrect.	Perform the correct upgrade package again.

B Common Emission Rate

Emission Rate

The emission rate is the capability of an object to emit or absorb energy. An ideal transmitter provides an emission rate of emitting 100% of intake energy. An object with an emission rate of 0.8 can absorb 80% of intake energy, and reflect the remaining 20%. The emission rate is the ratio of the energy emitted by an object at a specific temperature to that emitted by an ideal radiator at the same temperature. The range of emission rate value is 0.0 to 1.0 generally.

Materials	Temperature (°C/°F)	Emissivity
Gold (High-purity)	227/440	0.02
Aluminum foil	27/81	0.04
Aluminum sheet	27/81	0.18
Aluminum used for families (flat)	23/73	0.01
Aluminum plate (98.3% purity)	227/440	0.04
	577/1070	0.06
Aluminum plate (rough)	26/78	0.06
Aluminum (oxidized @ 599°C)	199/390	0.11
	599/1110	0.19
Polished aluminum	38/100	0.22
Tin (light tinned Iron sheet)	25/77	0.04
Nickel wire	187/368	0.1
Lead (99.9% purity, No oxidized)	127/260	0.06
Copper	199/390	0.18
Cobalt	599/1110	0.19

Steel	199/390	0.52
	599/1110	0.57
Tinned iron sheet (Light)	28/82	0.23
Brass(High-polish)	247/476	0.03
Brass (Tough rolled, polished metal wire)	21/70	0.04
Tinned Iron (Light)	-	0.13
Iron plate (Rust eaten)	20/68	0.69
Rolled steel sheet	21/71	0.66
Ferric oxide	100/212	0.74
Wrought-iron	21/70	0.94
Fused iron	1299-1399/3270-2550	0.29
Copper (Polished)	21-117/70-242	0.02
Copper(Polished, not reflected)	22/72	0.07
Copper (Heavy oxide Board)	25/77	0.78
Enamel (Fuse on iron)	19/66	0.9
Formica Plate	27/81	0.94
Frozen soil	-	0.93
Brick (Red, rough)	21/70	0.93
Brick (Unglazed, rough)	1000/1832	0.8
Carbon (T - carbon 0.9% ash)	127/260	0.81
Concrete	-	0.94
Glass (Glossy)	22/72	0.94

B Common Emission Rate

Granite (Surfaced)	21/70	0.85
Ice	0/32	0.97
Marble (I Polished, grey)	22/72	0.93
Asbestos board	23/74	0.96
Asbestos paper	38/100	0.93
	371/700	0.95
Asphalt (Paving the road)	4/39	0.97
Paper (Black tar)	-	0.93
Paper (White)	-	0.95
Plastic (White)	-	0.91

170-16-20-0084-01