

Bi-Spectrum PTZ Network Camera User Manual



Issue

V1.2

Date

2025-03-04





Precautions

Precautions

Fully understand this document before using this device, and strictly observe the rules in this document when using this device. If you install this device in public places, provide the tip "You have entered the area of electronic surveillance" in an eye-catching place. Failure to correctly use electrical products may cause fire and severe injuries. To prevent accidents, carefully read the following context:

Symbols

This document may contain the following symbols whose meanings are described accordingly.

Symbol	Description
 DANGER	It alerts you to fatal dangers which, if not avoided, may cause deaths or severe injuries.
 WARNING	It alerts you to moderate dangers which, if not avoided, may cause minor or moderate injuries.
 CAUTION	It alerts you to risks. Neglect of these risks may cause device damage, data loss, device performance deterioration, or unpredictable results.
 TIP	It provides a tip that may help you resolve problems or save time.
 NOTE	It provides additional information.



DANGER

To prevent electric shocks or other dangers, keep power plugs dry and clean.



WARNING

Strictly observe installation requirements when installing the device. The manufacturer shall not be held responsible for device damage caused by users' non-conformance to these requirements.

Strictly conform to local electrical safety standards and use power adapters that are marked with the LPS standard when installing and using this device. Otherwise, this device may be damaged.

Use accessories delivered with this device. The voltage must meet input voltage requirements for this device.

If this device is installed in places with unsteady voltage, ground this device to discharge high energy such as electrical surges to prevent the power supply from burning out.

When this device is in use, ensure that no water or any liquid flows into the device. If water or liquid unexpectedly flows into the device, immediately power off the device and disconnect all cables (such as power cables and network cables) from this device.

Do not expose the thermal imaging camera or unpacked product to extremely strong radiation sources, such as the sun, laser, or arc welding machine, regardless of whether the device is being electrified or not; do not put the camera close to high thermal objects such as the sunlight; otherwise, the precision of the camera may be affected and even the detector inside the camera may suffer permanent damage.

If this device is installed in places where thunder and lightning frequently occur, ground the device nearby to discharge high energy such as thunder strikes to prevent device damage.



CAUTION

Unless otherwise specified, do not use the camera in a temperature lower than $-20\text{ }^{\circ}\text{C}$ ($-4\text{ }^{\circ}\text{F}$) or higher than $+60\text{ }^{\circ}\text{C}$ ($+140\text{ }^{\circ}\text{F}$). Too-high or too-low temperature may cause image display anomaly of the camera and the camera will be damaged if it is working under such a condition for a long time.

If the camera is installed outdoors, avoid direct sunlight at dawn and dusk on the camera lens and install a sunshield with frontal and rear positions adjusted according to the sunlight angle.

Avoid heavy loads, intensive shakes, and soaking to prevent damage during transportation and storage. The warranty does not cover any device damage that is caused during secondary packaging and transportation after the original packaging is taken apart.

Protect this device from fall-down and intensive strikes, keep the device away from magnetic field interference, and do not install the device in places with shaking surfaces or under shocks.

Clean the device with a soft dry cloth. For stubborn dirt, dip the cloth into a slightly neutral cleanser, gently wipe the dirt with the cloth, and then dry the device.

Since the camera lens is painted with a durable coating material, it adapts to an outdoor environment. The lens must be cleaned regularly. If the image quality is reduced or excessive dirt is deposited on the lens, clean the lens promptly. In sandy (in desert) or corrosive (on sea) environments, use the camera with caution; improper use may cause the coating to peel off.

Do not jam the ventilation opening. Follow the installation instructions provided in this document when installing the device.

Keep the device away from heat sources such as radiators, electric heaters, or other heat equipment.

Keep the device away from moist, dusty, extremely hot or cold places, or places with strong electric radiation.

If the device is installed outdoors, take insect- and moisture-proof measures to avoid circuit board corrosion that can affect monitoring.

Remove the power plug if the device is idle for a long time.

Before unpacking, check whether the fragile sticker is damaged. If the fragile sticker is damaged, contact customer services or sales personnel. The manufacturer shall not be held responsible for any artificial damage to the fragile sticker.

Special Announcement

All complete products sold by the manufacturer are delivered along with nameplates, operation instructions, and accessories after strict inspection. The manufacturer shall not be held responsible for counterfeit products.

This manual may contain misprints, technology information that is not accurate enough, or product function and operation descriptions that are slightly inconsistent with the actual product. The manufacturer will update this manual according to product function enhancement or changes and regularly update the software and hardware described in this manual. Update information will be added to new versions of this manual without prior notice.

This manual is only for reference and does not ensure that the information is consistent with the actual product. For consistency, see the actual product.

Contents

Precautions	i
Precautions	i
Symbols	i
Special Announcement	iii
Contents	iv
1 Overview	1
1.1 Principle of Thermal Imaging and Advantages	1
1.2 Product Introduction	1
1.2.1 Function	2
1.2.2 Product Features	2
1.3 Description of PTZ cable	3
1.3.1 Aviation Power Supply and Network Cable of Twenty-six Cores	3
1.3.2 Aviation Alarm Cable of Twenty-Six Cores	4
1.4 Device Dimensions	7
1.5 Device Installation	9
1.5.2 Installation of Basic Requirements	9
1.5.3 Basic Installation Tool	9
1.5.4 Installation Space and Installation Strength	10
1.5.5 Definition of Installation Wiring Harness	10
2 Device Login	11
2.1 Login and Logout	11
2.2 Change Password	14
2.3 Homepage Layout	15
2.4 Playback	18
2.5 IVS Setting	21
3 Quick Start Settings	23
3.1 Local Network	23
3.2 Video	26
3.3 Image Display of Thermal Channel	30
3.3.1 Mode	30

3.3.2	Image	31
3.3.3	Scene.....	31
3.3.4	Set Pseudocolor	32
3.3.5	FFC Control.....	34
3.3.6	Noise Reduction.....	35
3.3.7	Lens control	36
3.4	OSD.....	37
3.5	Date and Time.....	40
4	Configuring Thermal	42
4.1	Settings	42
4.1.1	Temperature Parameters.....	42
4.1.2	Ambient Temperature.....	48
4.1.3	Privacy Zone Masking	49
4.1.4	Defect Pixel Correction	50
4.1.5	Version Information	52
4.2	Temperature Alarm	52
4.3	Schedule Linkage	59
5	IVS Settings	62
5.1	AI Multi-Target.....	62
5.2	Intelligent Analysis	63
5.2.1	Intrusion.....	63
5.2.2	Smart Motion.....	66
5.2.3	Single Line Crossing.....	67
5.2.4	Double Line Crossing	69
5.2.5	Multi-Loitering	71
5.2.6	Wrong -Way.....	71
5.2.7	Enter Area.....	72
5.2.8	Leave Area.....	73
5.3	Environmental Safety Analysis.....	74
5.3.1	Smoking Detection	74
5.3.2	Fire Spot Detection	75
5.4	People Counting	77
5.4.1	Set.....	77
5.4.2	Report	79
6	PTZ Function Settings.....	81
6.1	PTZ Control function.....	81

6.2 PTZ configuration.....	83
6.2.1 PTZ setting	83
6.2.2 Configure and Apply Home	85
6.2.3 Configure and Apply Preset	85
6.2.4 Configure and Apply Tracks	87
6.2.5 Configure and Apply Scan	88
6.2.6 Configure and Apply Tour	90
6.2.7 Configure and Apply Bow Scan.....	91
6.2.8 Configure and Apply Idle.....	92
6.2.9 Configure Timer.....	92
6.2.10 Configure Power UP Action	93
6.2.11 Configure Intelligent Tracking.....	94
6.2.12 Dome PTZ	96
7 Optical Channel.....	98
7.1 Image Display.....	98
7.1.1 Access the Display Settings	98
7.1.2 Mode.....	99
7.1.3 Image Setting.....	99
7.1.4 Scene Mode	100
7.1.5 Exposure	101
7.1.6 White Balance Setting.....	103
7.1.7 Day/Night	104
7.1.8 Noise Reduction.....	107
7.1.9 Image Enhancement.....	109
7.1.10 Zoom Focus	110
7.2 Configure AI Multi-Target.....	112
7.3 Smoke and Flame Detection.....	113
A Troubleshooting	115
B Common Emission Rate	118

1 Overview

1.1 Principle of Thermal Imaging and Advantages

Any object with a temperature higher than absolute zero (-273.15° F) will emit an infrared (IR) ray, even though it does not emit light. The IR ray is also called thermal radiation. IR rays emitted by objects with different temperatures can be absorbed by the detector to reflect temperature change and thus generate an electric effect. The electric signal is amplified and processed to produce a thermal image that corresponds to the thermal distribution of the object's surface. This is the process of thermal imaging.

Adapt to any environment.

Traditional cameras rely on natural or environmental light to shoot images, but this IR thermal imaging camera relies on the IR energy radiated by an object itself to form an image, not requiring any light. The IR thermal imaging camera applies to any environment and is not affected by light strength. It can detect and identify any camouflage and concealed object both in daytime and nighttime, implementing round-the-clock monitoring.

Monitor the temperature field with object energy distributed.

The IR thermal imaging camera can show the temperature field of an object, converting the invisible surface temperature distribution situation to a visible thermal image that reflects the surface temperature distribution situation of the object. By this monitoring, users can discover temperature anomalies on time and take precautionary measures to avoid any risk that may be caused by the anomaly, for example, a fire.

Boast cloud penetration capability

Optical-light and near IR rays will be absorbed by the air, cloud, and smoke, but they are transparent to IR rays of the 3~5 μm Medium Wavelength Infrared

(MWIR) region and 8~14 μm Long Wavelength Infrared (LWIR) region.

Traditional cameras cannot shoot clear images in cloudy environments, but the IR thermal imaging camera can penetrate the cloud and smoke to shoot clear images.

1.2 Product Introduction

The bi-spectrum PTZ Network Camera, the whole machine shell, and the base are all made of high-strength aluminum alloy material with comprehensive function and high stability. Can adapt to a variety of bad environments, heavy load can reach more than 50kg and run smoothly. This series has 360°continuous rotation,

automatic scanning, automatic cruise, and other functions, suitable for large areas of monitoring, can be widely used in airports, stations, urban roads, traffic survey and monitoring, forest fire prevention, the high and heavy equipment rotary control, and other important area.

1.2.1 Function

To support a variety of scanning methods, such as cruise scan, pattern scanning, etc.

It supports the function of power-off memory and automatically returns to the monitoring scene before power off.

Support network signal and analog signal double output, cloud platform control classification operation.

The double helix structure of the worm gear and worm drive, the electronic image stabilization, and mechanical locking design, power self-locking function.

Horizontal continuous rotation 360°, vertically +40° ~- 75° rotating, horizontal velocity is 0.01°~60 °/S, vertical speed of 0.01° ~ 30°/S

Support proportion variable times function, rotation speed adjusted automatically according to the lens change multiple times.

Support watch features preset point/figure/cruise can stay idle scan specified Automatic call after time (including the idle state entered after power).

1.2.2 Product Features

Outdoor intelligent variable speed PTZ, the fuselage selection of high-strength aluminum alloy material, and exterior design can resist strong winds, smooth operation, and high precision.

Products using high-precision stepper motor and precision worm gear drive combination, power can be self-locking.

Support a variety of lens preset functions, and zoom adaptive functions, the rotation speed can be automatically adjusted according to the lens zoom factor.

Powerful, with preset, cruise, line sweep, keep watch and other functions.

Visual pitch angle range, monitoring a wide range of horizontal speed up to 6° / s.

The equipment has an automatic heating system, low temperature automatically starts the heating function, to ensure that products can be applied to cold areas.

Network transmission signal can reach 100Mbps.

The device supports the RS485 / RS422 communication interface, you can remotely upgrade the device program, easy to maintain.

Power failure memory function, accidental power after re-power, the memory of the last running state, can be restored to power before the running state.

1.3 Description of PTZ cable

1.3.1 Aviation Power Supply and Network Cable of Twenty-six Cores

Aviation power supply and network cable of twenty-six cores is shown in Figure 1-1 & Figure 1-2, and the description is shown in Table 1-1.

Figure 1-1 Aviation power supply and network cable of twenty-six cores



Figure 1-2 Definition of twenty-six cores

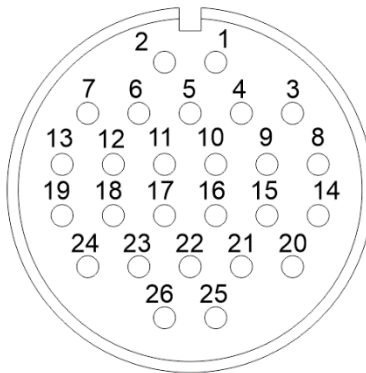

Table 1-1 Description of twenty-six cores

SN	Name	Description
1	DC36V-	Black (Thick)
2	DC36V+	Red (Thick)
3	DC36V-	Black (Thick)
4	DC36V-	Black (Thick)
5	Alarm_OUT1	Red (Thin)
6	DC36V+	Red (Thick)
7	DC36V+	Red (Thick)
8	Audio_IN(G)	Audio masking
9	Audio_IN	Audio Core
10	Alarm_OUT1	Black (Thin)
11	Alarm_OUT3	Blue
12	Alarm_OUT3	Pink
13	Alarm_OUT4	White
14	Audio_OUT(G)	Audio masking
15	Audio_OUT	Audio Core
16	Video	Video Core
17	Video (G)	Video masking
18	Alarm_OUT2	White and Orange
19	Alarm_OUT4	Green
20	RS485A	Orange (Thick)
21	RS485B	Yellow (Thick)
22	ETHTX+	White and Orange
23	ETHTX-	Orange
24	Alarm_OUT2	White and Yellow
25	ETHRX+	White and Green
26	ETHRX-	Green

1.3.2 Aviation Alarm Cable of Twenty-Six Cores

The aviation alarm cable of twenty-six cores is shown in Figure 1-3& Figure 1-4, and the description is shown in Table 1-2.

Figure 1-3 Aviation power supply cable of twenty-six cores



Figure 1-4 Definition of twenty-six cores

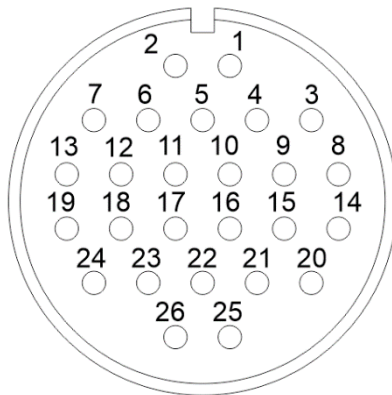

Table 1-2 Description of twelve cores

SN	Name	Description
1	Reserved core	Blank

SN	Name	Description
2	Reserved core	Blank
3	Reserved core	Blank
4	Reserved core	Blank
5	Reserved core	Ground
6	Reserved core	Blank
7	Reserved core	Blank
8	Reserved core	Ground
9	Reserved core	Ground
10	Reserved core	Blank
11	Alarm_IN1	White
12	Alarm_IN2	White and Orange
13	Alarm_IN3	Blue
14	Audio_IN(G)	Audio masking
15	Audio_IN	Audio Core
16	Video	Video Core
17	Video (G)	Video masking
18	Audio_OUT	Audio Core
19	Audio_OUT(G)	Audio masking
20	Alarm_IN4	Pink
21	Alarm_IN5	Red (Thin)
22	Alarm_IN6	White and Yellow
23	Alarm_IN7	Blank
24	Alarm_IN8	Yellow (Thick)
25	Alarm_IN9	Orange (Thick)
26	Alarm_G	Black (Thick)

---End

1.4 Device Dimensions

Figure 1-5 shows the dimensions of the Bi-Spectrum PTZ Network Camera.

Figure 1-5 Dimensions of 25/50/75 mm lens (unit: mm)

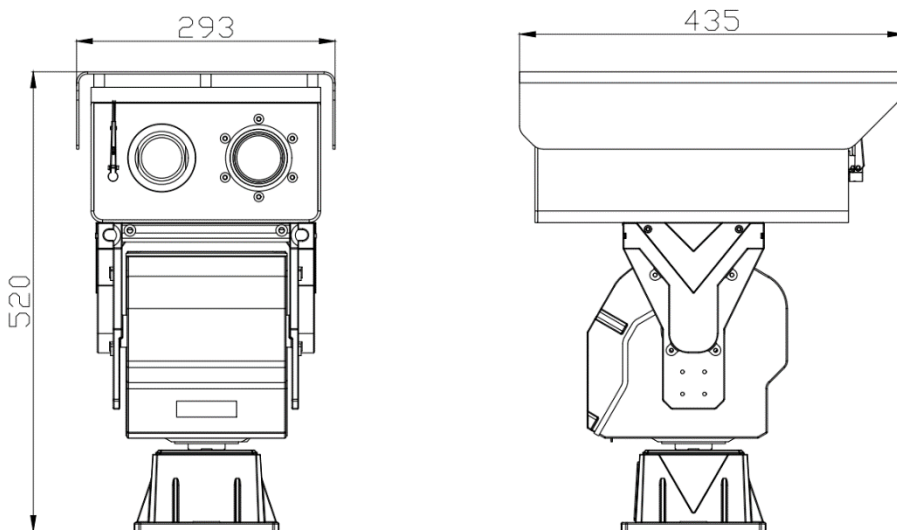
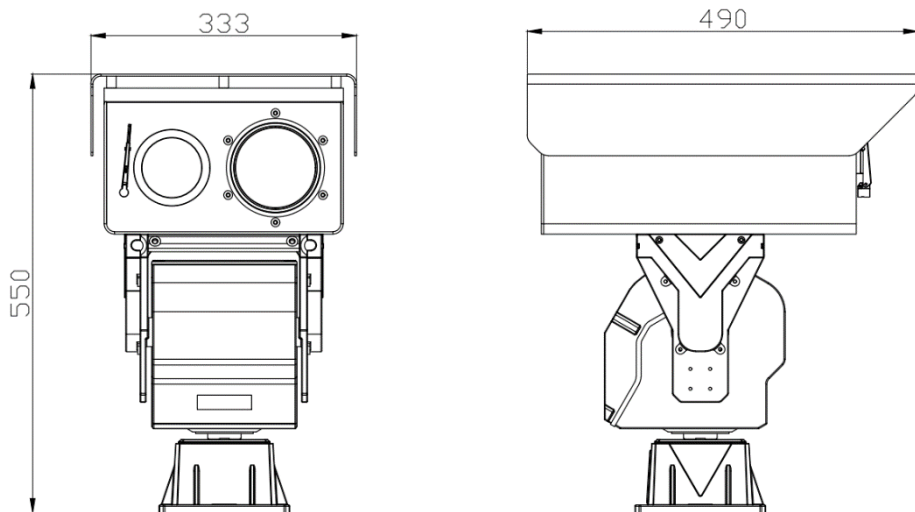

Figure 1-6 Dimensions of 100 mm lens (unit: mm)



1.5 Device Installation

Bi-Spectrum PTZ Network Camera can be installed on the camera base.

Figure 1-7 Base dimensions of PTZ camera (unit: mm)

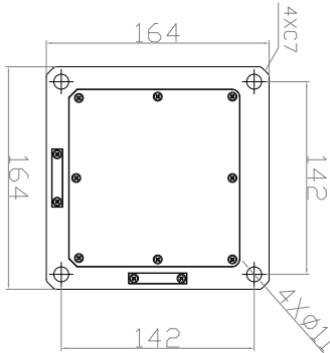

1.5.2 Installation of Basic Requirements

Installation site and environment to meet the technical parameters mentioned in the requirements, the installation staff should have fully read and read the contents of this manual, with the appropriate system installation qualification and maintenance work qualification certificate.

1.5.3 Basic Installation Tool

Commonly used engineering wiring and equipment installation tools, please install the equipment before the preparation is complete.

Table 1-3 shows the installation tools list.

Table 1-3 Installation tools

Name	Quantity	Remarks
13mm wrench	1	For mounting fixtures and mounting brackets
14mm sleeve	1	
Cross screwdriver(big)	1	For common construction
Cross screwdriver(small)	1	Used to disassemble the DIP cover to adjust the device communication parameters
Inside the hex wrench	1 set	Used for disassembly of pan/tilt pallet and shield connection
Word screwdriver (small)	1	to secure the wiring harness connection terminals

Wire strippers	1	Stripping
----------------	---	-----------

1.5.4 Installation Space and Installation Strength

Under normal circumstances, this device needs to be equipped with a protective cover or other overhead items, please confirm the installation location can accommodate this product and the equipment and installation of the structure of the space. To confirm the installation of the wall, the carrying capacity of the bracket can reach 4 times the safety of the entire equipment weight.

1.5.5 Definition of Installation Wiring Harness

The bottom line includes power line, network cable, RS422, geodetic line, and video line, and according to the demand, there are various types of outgoing lines. The details need to be controlled according to the line signature of each device.

Table 1-4 shows the Definition of the installation wiring harness.

Table 1-4 Definition of installation wiring harness

COLOR	Function define	Remark
BNC	Video	Optional
Red	DC36V+	
Black	DC36V-	
RJ45	Network cable	
Orange	RS422 TX+	
Yellow	RS422 TX-	
Red	RS422 RX+	
Blue	RS422 RX-	
Yellow & Green	GND	

NOTE

To prevent lightning strikes, the grounding wire (yellow-green wire) in the cable outlet base must be grounded reliably and the grounding resistance should be $<4\Omega$.

---End

2 Device Login

2.1 Login and Logout



CAUTION

To access the web interface through Microsoft Edge, Chrome, or Firefox browser; Otherwise, some functions may be unavailable.

Login

- Step 1 Open Chrome browser, enter the IP address of the IP camera (The default value of the thermal channel is 192.168.0.121, for the optical channel is 192.168.0.120) in the address box, and click on the **Enter** button.
- Step 2 Create a password when you log in for the first time, then jump to the login interface.

Figure 2-1 Create password

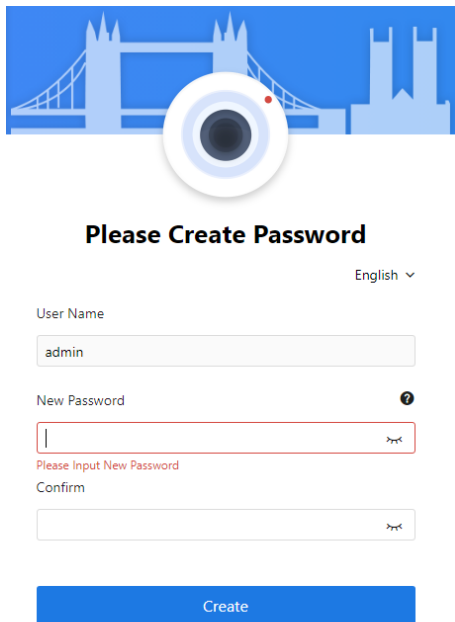

English ▾

User Name

New Password 

Please Input New Password

Confirm

Create

Step 3 Enter the user name and password. The login page is displayed, as shown in Figure 2-2.

Figure 2-2 Login page

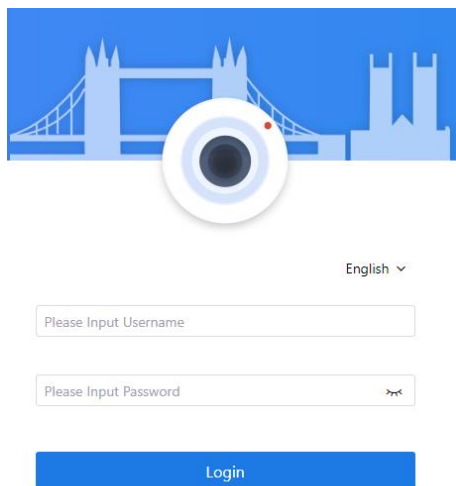

 **NOTE**

The default username is admin. Users should create the password for the first time login.

DHCP is on by default. Please use the tool to search IP, the default IP address of thermal channel is 192.168.0.121, the default IP address of optical channel is 192.168.0.120.

After modifying the password, you need to wait at least three minutes and then power off to make sure modify it successfully. Or login the Web again to test the new password.

You can change the system display language on the login page.

Step 4 Click **Login** to enter the homepage.

----End

Sign out

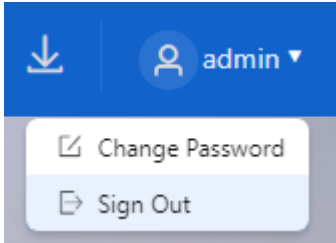

Click **Sign Out** to sign out in the upper right to return to the login page.

2.2 Change Password

Description

Step 1 Click the username on the upper right, and choose **Change Password** to enter the change password as shown in Figure 2-3. Or choose **Setting > System > Change Password**.

Figure 2-3 Change the default password page

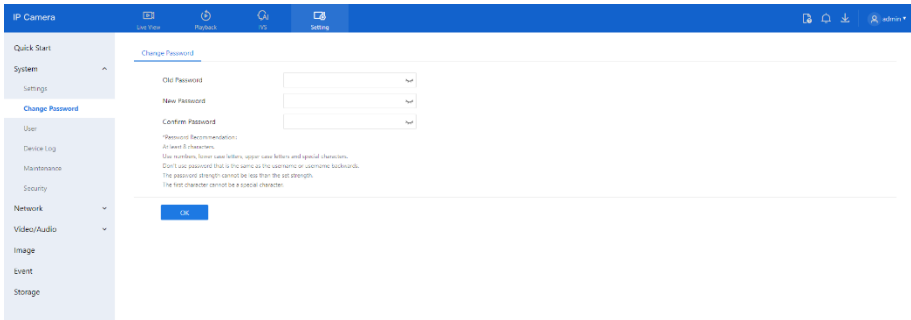

Step 2 Input the old password, and new password, and confirm the password.

Step 3 Click **OK**.

If the message "Change your password success!" pops up, the password is successfully changed. If the password fails to be changed, there will be some tips for changing the password. (For example, the new password length couldn't be less than eight.).

It is advised to restart the device three minutes later after modifying the password.

Step 4 Click **OK**. The login page is displayed.

----End

2.3 Homepage Layout

On the homepage, you can view real-time videos, receive alarm and fault notifications, set parameters, change the password, and log out of the system. The figure shows the homepage layout. Table 2-1 describes the elements on the homepage.







Figure 2-4 Homepage layout of thermal channel











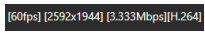

Figure 2-5 Homepage layout of optical channel



Table 2-1 Elements on the homepage

No.	Element	Description
1	Live View	Real-time videos are played on this page.
2	Playback	You can query the playback videos in this area. NOTE Only when the SD card or NAS has videos can you query the playback videos.
3	IVS setting	Intelligent Video System, set the ai multi-target, intelligent analysis (intrusion, smart motion, single line crossing, double line crossing, multi-loitering, wrong-way, general parameters), environmental safety analysis (Thermal channel: smoking detection, and fire spot detection; Optical channel: smoke and flame detection) people counting and so on.
4	Thermal	Set the parameters of thermal, such as temperature parameters, temperature alarm, schedule linkage, LED control, and so on. This function is only applicable to thermal channels.
5	Setting	You can choose a menu to set device parameters, quick start, system, network, audio /video, image, event, and storage.
6		About the intercom function.
7		When the device accepts an alarm signal, the alarm icon will display  . You can click  to view the alarm information.
8		SD card video backup and download status.
9	 admin ▾	Current user, sign out or change password.
10		Set brightness, saturation, contrast, and sharpness. For motorized lenses, users can control the lens here.

No.	Element	Description
11	The menu	Zoom +/- zoom - Iris +/- iris - Near focus /far focus Set the PTZ and image parameters.
12		Window scale, switch the scale of playing live video.
13		Full screen, click the icon to play live video at full screen.
14		Stream, click the icon to switch stream. There are two modes of stream of thermal channel; There are three modes of stream of optical channel.
15		Pause/Start. Close live video or play live video.
16		Audio. Open or close audio.
17		Two-way audio. Open or close the intercom, the computer should be plugged into a microphone in advance.
18		Click the icon to snapshot the video and save the images to the specified location.
19		Record the video and save the file to the specified location.
20		For the optical channel, the AI snapshot, click the icon to enter the real-time snapshot of the multi-target.
21		<div data-bbox="437 1046 723 1174" style="background-color: #333; color: #fff; padding: 10px; margin-bottom: 10px;"> <p>Target Frame</p> <p>Intelligent marking</p> </div> <p>Target frame: when detecting the target, it will show a frame on the target.</p> <p>Intelligent marking: the detection area frame of the intelligent analysis in IVS will be displayed in the live video interface.</p>
22		Frame rate / resolution / bit rate / video encode type.

No.	Element	Description
23		I/O output controls the I/O alarm output manually.  Click to open the alarm or close the alarm.

Figure 2-6 About the intercom function



2.4 Playback



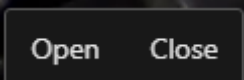
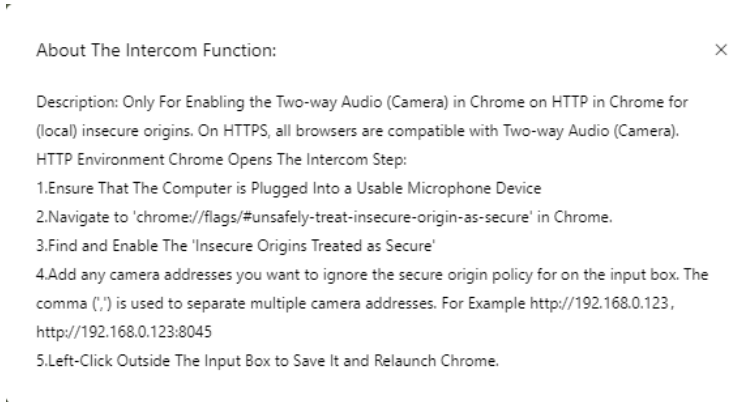





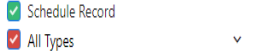

Click “Playback” on the web interface. If users install a micro SD card, and there are videos on the SD card. Click “Playback” and the playback video will show as in Figure 2-7.

Figure 2-7 Playback page



Table 2-2 Playback function

No.	Element	Description
1	Channel	The channel list of cameras.
2	Calender	 the green point means it has a recording video. Set the time to play the recording.

3		<p>All Types</p> <p>I/O Alarm</p> <p>Motion Alarm</p> <p>Day/Night Switch Alarm</p> <p>Abnormal Audio Alarm</p> <p>Intrusion</p> <p>Smart Motion</p> <p>Single Line Crossing</p> <p>Double Line Crossing</p> <p><u>Multi-Loitering</u></p> <p>The green timeline represents scheduled recording and the red timeline is alarm recording. The types of alarm recordings vary according to model performance.</p>
4		<p>One screen plays a recording. Choose one day that has a recording, click  to play.</p>
5		<p>Two screens play the recording. Choose the screen, choose the channel, select one day that has a recording(the date shows a green point), and click  to play.</p>
6		<p>Four screens play recording. Choose the screen, choose the channel, select one day that has a recording(the date shows a green point), and click  to play.</p>
7		<p>Window scale, switch the scale of play recording video.</p>
8		<p>Full screen, click the icon to play recording video at full screen.</p>
9		<p>Pause/Start. Close the live video or play the recording video.</p>





10		Audio. Open or close audio.
11		Click the icon to snapshot the video and save the images to the specified location.
12		Fast Forward, 1/16X, 1/8 X, 1/4 X, 1/2 X, 1 X, 2 X, 4 X, 8 X
13		<p>Click the icon to start backup, drag the bar to download the recording quickly, and click the icon again to end up. In the pop-up window of the tip as shown in Figure 2-8, click the save to save the video. Click Cancel to abandon.</p>  <p>Backup Download List × the backup list to show the detail information.</p>
14		Time axis, users can choose 1h, 6h, 12h, 24h.

Figure 2-8 Record backup tip



2.5 IVS Setting

Click IVS to enter the IVS setting page, users can set the deep learning, intelligent analysis, and behavior analysis as shown in Figure 2-9. The detail settings will be introduced in the following chapters.

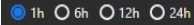
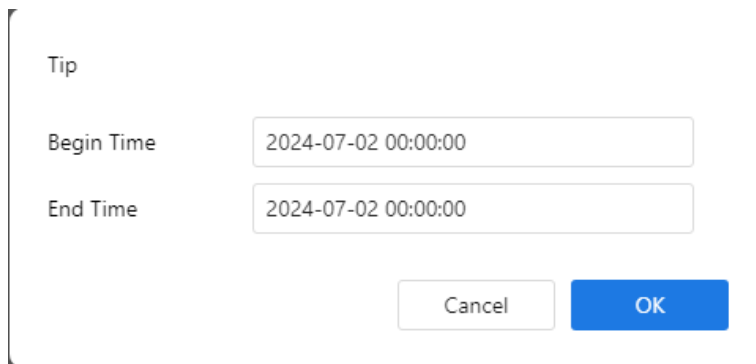
Figure 2-9 IVS setting page

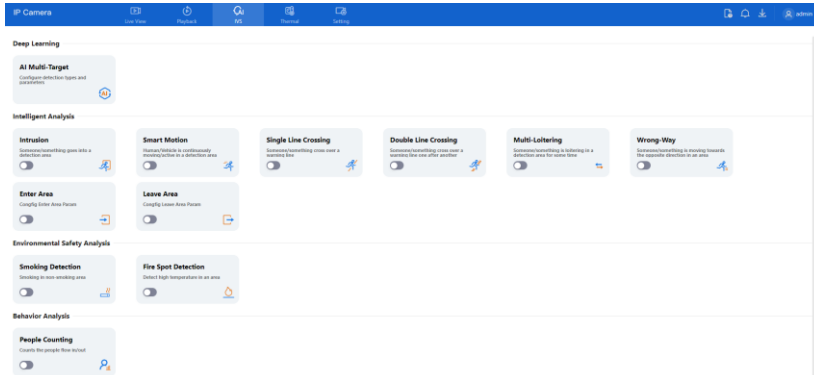

 **NOTE**

The different models have different IVS functions, please refer to the actual product.

----End

3 Quick Start Settings

To use the camera quickly, users to set the Local Network, Video, Display, OSD, Date, and Time at the Quick Start interface.

3.1 Local Network

Description

Local network parameters include:

- IP protocol

- IP address

- Subnet mask

- Default gateway

- Dynamic Host Configuration Protocol (DHCP)

- Preferred Domain Name System (DNS) server

- Alternate DNS server

- MTU

The device has DHCP enabled by default. When the device is connected to a network router with DHCP functionality, it will be automatically assigned an IP address. Otherwise, it will use the default address 192.168.0.120 for the optical channel, and 192.168.0.121 for the thermal channel. If multiple devices are connected to the same network, users need to manually modify the management IP addresses.

Procedure

Step 1 Choose **Setting > Quick Start > Local Network**.

The **Local Network** page is displayed, as shown in Figure 3-1.

Figure 3-1 Local network page

The screenshot shows the 'Local Network' configuration page. On the left is a navigation menu with categories: System, Network, Video/Audio, Image, Event, and Storage. The main content area has tabs for 'Local Network', 'Video', 'Display', 'OSD', and 'Date and Time'. Under 'Local Network', the following settings are visible:

- Network Card ID: 1
- IP Protocol: IPv4
- DHCP: Disabled (toggle off)
- IP Address: 192.168.0.67
- Subnet Mask: 255.255.255.0
- Default Gateway: 192.168.0.1
- DNS: Enabled (toggle on)
- Preferred DNS Server: 114.114.114.114
- Alternate DNS Server: 8.8.8.8
- MTU: 1500

An 'Apply' button is located at the bottom of the configuration area.

Step 2 Set the parameters according to Table 3-1.

Table 3-1 Local network parameters

Parameter	Description	Setting
Network Card ID	--	[Default value] 1
IP Protocol	IPv4 is the IP protocol that uses an address length of 32 bits. IPv6 is the IP protocol that uses an address length of 64 bits.	[Setting method] Select a value from the drop-down list box. [Default value] IPv4
DHCP	Enable DHCP, and the device will automatically obtain the IP address from the DHCP server.	[Setting method] Click the button to enable DHCP . NOTE To query the current IP address of the device, you must query it on the

Parameter	Description	Setting
		platform based on the device name.
IP Address	Device IP address that can be set as required.	[Setting method] Enter a value manually. [Default value] 192.168.0.121
Subnet Mask	DHCP is off. The subnet mask of the network adapter.	[Setting method] Enter a value manually. [Default value] 255.255.255.0
Default Gateway	DHCP is off. This parameter must be set if the client accesses the device through a gateway.	[Setting method] Enter a value manually. [Default value] 192.168.0.1
Preferred DNS Server	DNS is on. The IP address of a DNS server.	[Setting method] Enter a value manually. [Default value] 192.168.0.1
Alternate DNS Server	DNS is on. The IP address of a domain server. If the preferred DNS server is faulty, the device uses the alternate DNS server to resolve domain names.	[Setting method] Enter a value manually. [Default value] 192.168.0.2
MTU	Set the maximum value of network transmission data packets.	[Setting method] Enter a value manually. NOTE The MTU value ranges from 1280 to 1500, the default value is 1500, Please do not change it arbitrarily.

Step 3 Click **Apply**.

If the message "Apply success!" is displayed, the system will save the settings.

The message "Set network parameter success, please login system again" is displayed. Use the new IP address to log in to the web management system.

If the message "Parameter is Invalid " is displayed, please set the parameters correctly.

----End

3.2 Video

Modifying video parameters can affect the quality of the real-time video, as well as the file size of playback and stored recordings. If network bandwidth or storage space changes, users can adjust the video parameters accordingly.

Procedure

Step 1 Choose **Setting > Quick Start > Video**.

The **Video** page is displayed, as shown in Figure 3-2.

Figure 3-2 Video setting page

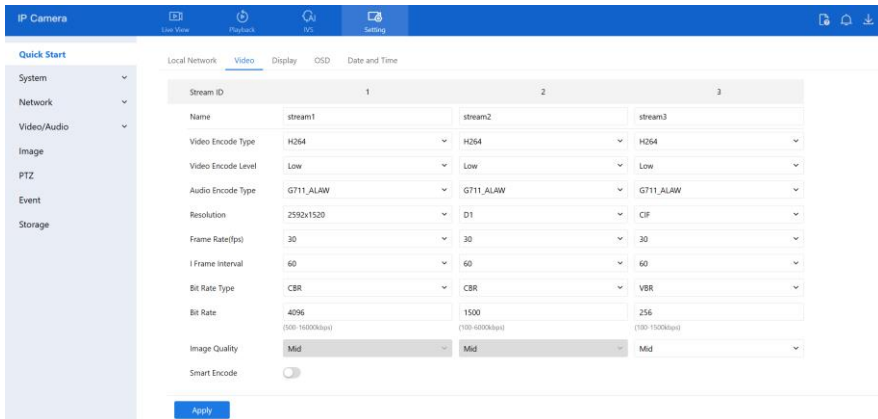

Step 2 Set the parameters according to Table 3-2.

Table 3-2 Parameters of stream configuration

Parameter	Description	Setting
Stream ID	<p>The device supports at most three streams.</p> <p>Streams 1 and 2 adopt the H.264 code.</p> <p>Stream 1 stands for the best stream performance of the device supports.</p> <p>Stream 2 usually offers comparatively low-resolution options.</p> <p>Stream 3 is the lowest resolution, for the optical channel.</p>	<p>[Setting method]</p> <p>Select a value from the drop-down list box.</p>

Parameter	Description	Setting
Name	Stream name. NOTE The stream name consists of characters, numbers, and underlines.	[Setting method] Enter a value manually. The value cannot exceed 32 bytes. [Default value] Stream 1

Parameter	Description	Setting
Video Encode Type	<p>The video encoding determines the image quality and network bandwidth required by a video. Currently, the following encoding standards are supported:</p> <p>MJPEG</p> <p>MJPEG is a standard intra-frame compression encode. The compressed image quality is good. No mosaic is displayed on motion images. MJPEG does not support proportional compression and requires large storage space. Recording and network transmission occupy large hard disk space and bandwidth. MJPEG does not apply to continuous recording for a long period or network transmission of videos. It can be used to send alarm images.</p> <p>Only the low video encode level can be chosen.</p> <p>H.264</p> <p>H.264 consists of H.264 low Profile, H.264 Main Profile, and H.264 High profile. The performance of H.264 High Profile is higher than that of H.264 Main Profile, and the performance of H.264 Main Profile is higher than that of H.264 Base Profile. If a hardware decoding device is used, select the appropriate encode based on the decoding performance of the device.</p> <p>H.264 High Profile has the highest requirements for hardware performance, and H.264 Base Profile has the lowest requirements for hardware performance.</p> <p>Three levels can be chosen</p> <p>H.265</p> <p>H.265 is the advanced video encoding standard. It's the improvement standard from H.264. H.265 improves the streams, encoding quality, and algorithm complexity to make configuration optimization.</p> <p>Only the Mid-video encode level can be chosen.</p>	<p>[Setting method] Select a value from the drop-down list box.</p> <p>[Default value] H.264 High Profile</p> <p>NOTE</p> <p>The H.264 High Profile encode means high requirements on the hardware. If the hard-decoding capability is low, use H.264 Main Profile or H.264 Base Profile.</p> <p>When users choose the MJPEG for Stream 1, some functions will be an error, such as the videos of FTP upload may not be played correctly.</p>
Audio Encode Level	<p>The following audio encoding standards are supported:</p> <p>G711_ULAW: mainly used in North America and Japan.</p> <p>G711_ALAW: mainly used in Europe and other areas.</p>	<p>[Setting method] Select a value from the drop-down list box.</p>

Parameter	Description	Setting
	RAW_PCM: encode of the original audio data. This encode is often used for platform data.	
Resolution	A higher resolution means better image quality. NOTE IP cameras support different resolutions based on the model.	[Setting method] Select a value from the drop-down list box.
Frame Rate(fps)	Frame rate is the number of images, snapshots, or frames that a camera can take per second. The frames per second determine the smoothness of a video. A video whose frame rate is higher than 22.5 f/s is considered smooth by human eyes. Frame rates for different frequencies are as follows: 50 Hz: 1–25 f/s 60 Hz: 1–30 f/s NOTE The frequency is set on the Device Configuration > Camera page. The biggest MJPEG coding format frame rate is 12 frames per second.	[Setting method] Select a value from the drop-down list
I Frame Interval(f)	I frame does not require other frames to decode. A smaller I-frame interval means better video quality but higher bandwidth.	[Setting method] Select a value from the drop-down list
Bit Rate Type	The bit rate is the number of bits transmitted per unit of time. The following bit rate types are supported: Constant bit rate (CBR) The compression speed is fast; however, improper bit rates may cause vague motion images. Variable bit rate (VBR) The bit rate changes according to the image complexity. The encoding efficiency is high and the definition of motion images can be ensured.	[Setting method] Select a value from the drop-down list box.
Bit Rate Range	Indicates the maximal value of the bit rate. The different models may have different ranges, please refer to the actual product.	[Setting method] Enter a value manually.
Image Quality	The video quality of the camera output.	[Setting method] Select a value from the drop-down list box.
Smart	Smart Encode.	[Setting method]

Parameter	Description	Setting
Encode	Smart encode includes H.264 & H.265. The storage space will be reduced by fifty percent when smart encode is enabled. Only mainstream supports smart encoding.	Click the button to enable Smart Encode .

Step 3 Click **Apply**.

If the message "Apply success!" is displayed, the system will save the settings.

If a message is "please enter the appropriate range", enter a new bit rate value.

The effect of modifying will be shown on live video or the saving recording.

----End

3.3 Image Display of Thermal Channel

There are two settings, current settings and edit settings. Modify the parameters in the edit setting. Four profiles can be set.

3.3.1 Mode

Step 1 Go to **Settings> Quick Start > Display**, and choose **Edit Settings** Click the **Mode** tag on the Display Settings interface, and the Mode page is displayed, as shown in Figure 3-3.

Figure 3-3 Mode page

Mode ▼

Switch Mode

Start Time :

End Time :

Step 2 Set the Mode parameters.

Step 3 Click **Apply** to save the setting.

----End

3.3.2 Image

Click **Setting > Quick Start > Display**, and choose **Image** item. The figure shows the image interface.

Figure 3-4 Image interface



The table describes the image setting parameters.

Table 3-3 Image setting parameter description

Parameter	Description	Setting
Brightness	It indicates the total brightness of an image. As the value increases, the image becomes brighter.	[Setting method] Drag the slider. [Default value] 50
Contrast	It indicates the contrast between the bright part and the dark part of an image. As the value increases, the contrast increases.	[Setting method] Drag the slider. [Default value] 50
Sharpness	It indicates the sharpness of the image plane and the sharpness of the image edge. The clearer the image, the better detail contrast.	[Setting method] Drag the slider. [Default value] 50

---End

3.3.3 Scene

Click **Setting > Quick Start > Display**, and choose **Scene** item. Figure 3-5 shows the scene interface.

Figure 3-5 Scene interface

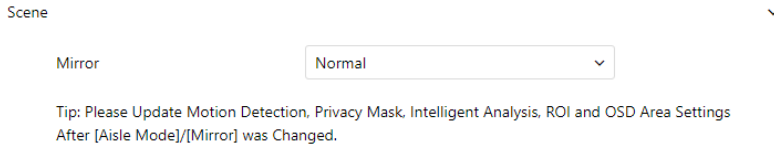

Provide the selection of image pixel locations.

Normal: the image is not flipped.

Horizontal: the image is flipped left and right.

Vertical: the image is flipped up and down.

Horizontal + Vertical: the image upside-down and reversal.

----**End**

3.3.4 Set Pseudocolor

Click **Setting > Quick Start > Display**, and choose the **Set Pseudocolor** item. Figure 3-6 shows the Set Pseudocolor interface.

Figure 3-6 Set Pseudocolor interface



Table 3-4 Pseudocolor parameter

Parameter	Description	Setting
Pseudo-Colors	<p>Polarity/LUT: the temperatures of the temperature fields detected by the thermal imaging camera are separately mapped to values ranging from 0 to 255 by the algorithm. In the black/white display mode, this range is converted to the grayscale tones. For example, 0 indicates completely black, and 255 indicates completely white. The temperature field of the scene is converted to images by using the grayscale ranging from 0 to 255. Different polarity modes can be converted to different display images. The most common setting is white hot (a hotter object is displayed brighter than a colder object) or black hot (a hotter object is displayed darker than a colder object). The difference between the two modes lies in that the temperatures corresponding to the darker one and the lighter one are reversed. Other modes include rainbow, iron bow, HSV, autumn, bone, and so on.</p>	<p>[How to set] Select from the drop-down list box. [Default value] White Hot</p>
Legend of Temperature Value	<p>It is on, the live video will show, otherwise there is no legend.</p>	<p>[How to set] Select from the drop-down list box. [Default value] Close</p>

3.3.5 FFC Control

Click **Setting > Quick Start > Display**, and choose the **FFC control** item. The figure shows the FFC control interface.

Figure 3-7 FFC control interface

FFC Control

FFC Mode: Auto

FFC Interval(min): 5

Temp deviation(0.1°C): 5

Shutter Correction

Background Correction

The table describes the FFC mode parameters.

Table 3-5 FFC control parameter description

Parameter	Description	Setting
FFC Mode	<p>The internal of the thermal imaging camera may comprise the mechanical action correction mechanism that can periodically improve the image quality. This component is called flat field correction (FFC). When controlling the FFC, the FFC shields the sensor array, so that each portion of the sensor can collect uniform temperature fields (flat field). Using FFC, the camera can update the correction coefficients to output more uniform images. Throughout the FFC process, the video image is frozen for two seconds and a static-frame image is displayed. After the FFC is complete, the image is automatically recovered. Repeated FFC operations can prevent grainy and image degradation problems. The FFC is especially important when the temperature of the camera changes. For example, after the camera is powered on or the ambient temperature is changed, you should immediately perform the FFC.</p> <p>Auto: In the Automatic FFC mode, the camera performs FFC whenever its temperature changes by a specified amount or at the end of a specified period (whichever comes first). When this mode</p>	<p>[How to set] Select from the drop-down list box. [Default value] Auto</p>

Parameter	Description	Setting
	<p>is selected, the FFC interval (minutes) ranges from 5 to 30 minutes. The temperature change of the camera is based on the temperatures collected by the internal temperature probe. The temperature of the camera sharply changes when the camera is powered on. The FFC is relatively frequent, which is normal.</p> <p>Manual: In the manual FFC mode, the camera does not automatically perform the FFC based on the temperature change or the specified period. You can press the Do FFC button to select the manual FFC mode. When you feel that the image is degraded but the automatic FFC is not performed, you can use the manual FFC function to check whether the image quality can be improved.</p>	
FFC Interval (min)	In the automatic FFC mode, the FFC interval ranges from 2 to 255 minutes.	<p>[How to set] Drag the slider. [Default value] 5</p>
Temper deviation(0.1°C)	In the automatic FFC mode, the FFC interval ranges from 0.2 to 25.5 centigrade.	<p>[How to set] Drag the slider. [Default value] 5</p>
Shutter Correction	Click the icon to adjust exposure immediately.	Click the button
Background Correction	Click the icon and cover the camera with something to adjust the image. Remove the thing to finish the adjustment.	Click the button

---End

3.3.6 Noise Reduction

Click **Setting > Quick Start > Display**, and choose the **Noise Reduction** item. The figure shows the Noise Reduction interface.

Figure 3-8 Noise reduction interface

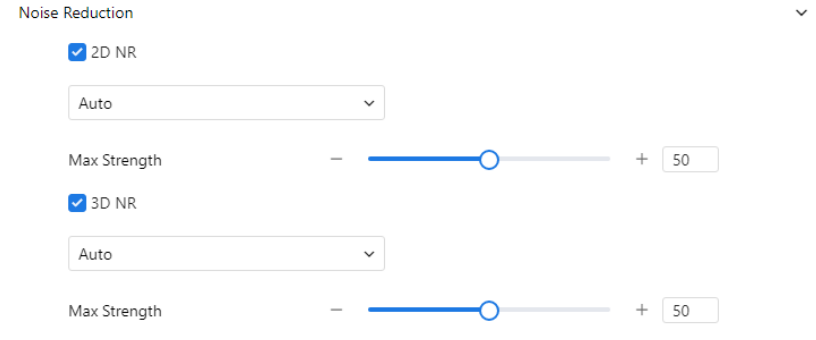

The table describes noise reduction parameters.

Table 3-6 DNR parameter description

Parameter	Description	Setting
2 DNR	Decrease the image noise.	[How to set] Select from the drop-down list box. Drag the slider to adjust the maximum strength. [Default value] Auto
3 DNR	Decrease the image noise.	[How to set] Select from the drop-down list box. Drag the slider to adjust the maximum strength. [Default value] Auto

---End

3.3.7 Lens control

Click **Setting > Quick Start > Display**, and choose **Lens control** item. Figure 3-9 shows the lens control interface.

Figure 3-9 Lens control

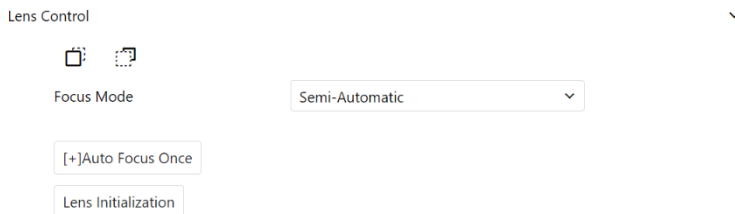

Table 3-7 Lens control parameter description

Parameter	Description	Setting
Focus Mode	Near focus/ far focus. Semi-Automatic or Manual	[How to set] Click the button
Auto Focus Once	Click to focus once automatically.	[How to set] Click the button
Lens Initialization	Click to initialize the lens	[How to set] Click the button

NOTE

All image settings can be modified at edit settings.
 Factory Reset: All parameters will be restored to the factory settings.
 Reset: the settings will be recovered to the last settings.

---End

3.4 OSD

Description

The on-screen display (OSD) function allows you to display the device name, channel ID and name, time, and other customized content on videos. You can drag the OSD frames to anywhere you want to put them.

When the resolution is D1 and CIF, the OSD customized in the web interface can show at most 22 words normally.

The OSD supports simplified Chinese, English, digital, and some special characters only.

Procedure

Step 1 Choose **Setting > Quick Start > OSD**.

The **OSD** page is displayed, as shown in 4.3 Step 4.

Figure 3-10 OSD

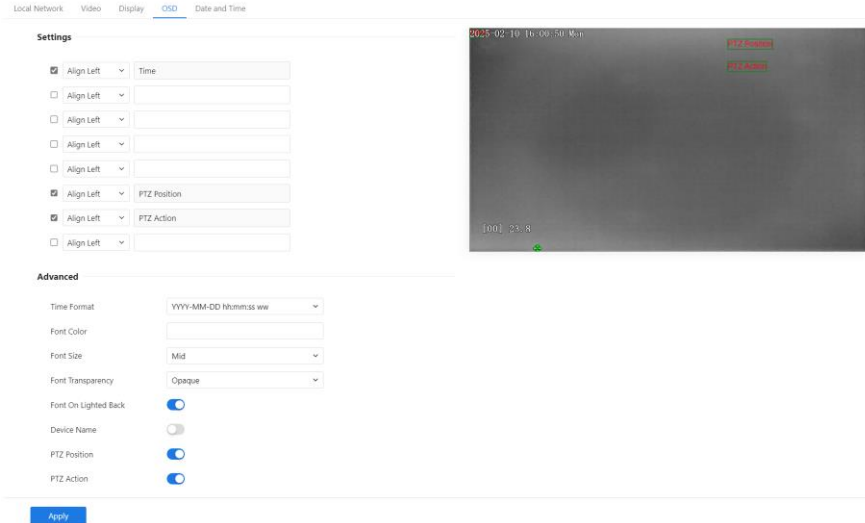

Step 2 Set the parameters according to Table 3-8.

 **NOTE**

There are no more than seven OSD display areas.

Table 3-8 Parameters of OSD

Parameter	Description	Setting
Time	Indicates whether to display the time.	[Setting method] Tick the time.
Settings	Custom OSD. Enables you to enter a line of characters.	[Setting method] Tick the custom OSD list. Set the position of OSD showing. Or drag the frame of OSD to adjust the position on live video. Enter the characters. Click Apply to save the value.
Time Format	Format in which the time is displayed.	[Setting method] Select a value from the drop-down list box. [Default value] YYYY-MM-DD hh:mm:ss ww

Parameter	Description	Setting
Font Color	Set the font color.	[Setting method] Select a value from the drop-down list box. [Default value] Blank
Font Size	Set the font size.	[Setting method] Select a value from the drop-down list box. [Default value] Mid
Font Transparency	Set the font transparency.	[Setting method] Select a value from the drop-down list box. [Default value] Opaque
Font on Lighted Back	Enable the font on the lighted back.	[Setting method] Click the button to enable Font on the lighted back .
Device Name	Indicates whether to display the device name.	[Setting method] Click the button to enable the Device Name
PTZ Action	The action of PTZ will be shown on live video.	[Setting method] Click the button to enable
PTZ Position	The position of PTZ will be shown on live video.	[Setting method] Click the button to enable
Twelve-hour System	The time format shows a twelve-hour system.	[Setting method] Click the button to enable
Display Week	The week will show.	[Setting method] Click the button to enable

Step 3 Click **Advanced**, set the parameter of “ Time Format”, “Font Color”, “Font Transparency”, “Font on lighted back”, and so on.

Step 4 Click **Apply**. The message "Apply success!" is displayed and the system will save the settings.

----**End**

3.5 Date and Time

Description

On the **Date and Time** page, you can modify the date and time. Parameters that can be set include:

- Time zone and daylight-saving time (DST)
- Date and time
- Network Time Protocol (NTP) server

Procedure

Step 1 Choose **Setting > Quick Start > Date and Time**.

The **Date and Time** page is displayed, as shown in Figure 3-11. Table 3-9 describes the parameters.

Figure 3-11 Date and time page

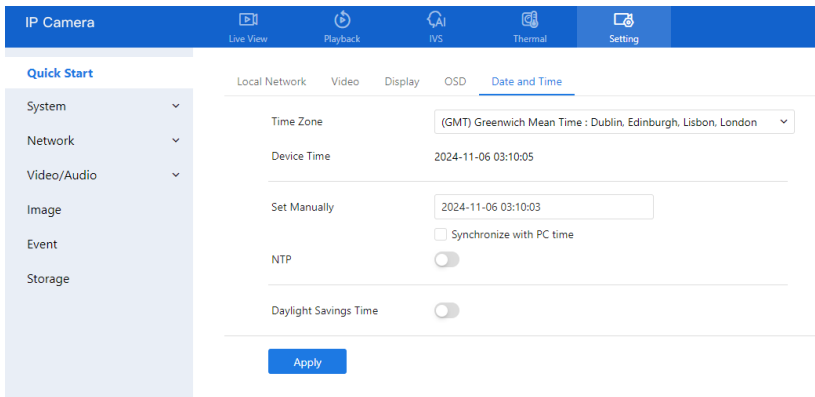

Table 3-9 Parameters of date and time

Parameter	Description	Setting
Time Zone	N/A	[Setting method] Select a value from the drop-down list box. [Default value] Greenwich mean time
Device Time	Device display time.	[Setting method] Synchronize the time from the PC. Enter a value manually.
Set Manually	You can set the device time manually or	[Setting method]

Parameter	Description	Setting
	synchronize it with PC time.	Click Set Manually and set the date and time in the format <i>YYYY-MM-DD HH:MM: SS</i> .
NTP	IP address or domain name of the NTP server.	[Setting method] Click the button to enable NTP and enter a value manually.
Server Address	NTP is enabled. The NTP server IP.	[Setting method] Enter a value manually.
Port	NTP is enabled. Port number of the NTP server.	[Setting method] Enter a value manually. [Default value] 123
Interval	NTP is enabled. Set time intervals to check if the device time has synchronized with the NTP server time.	[Setting method] Enter a value manually. [Default value] 60
Daylight Savings Time	When the DST start time arrives, the device time will automatically be one hour earlier. When the DST end time arrives, the device time will automatically be one hour later.	[Setting method] Click the button to enable Daylight Saving Time .

Step 2 Click **Apply**. The message "Apply success!" is displayed and the system will save the settings.

---End

4 Configuring Thermal

4.1 Settings

4.1.1 Temperature Parameters

Temperature parameters are the base parameters for measuring temperature, it includes temperature unit, ambient type, ambient temperature, cavity temperature, correctional coefficient, area temperature display mode, area temperature type, measure mode, area alarm interval, and so on.

Operation Procedure

Step 1 Choose **Thermal > Settings > Temperature Parameter**.

The **Temperature Parameters** page is displayed, as shown in Figure 4-1.

Figure 4-1 Temperature Parameters Interface

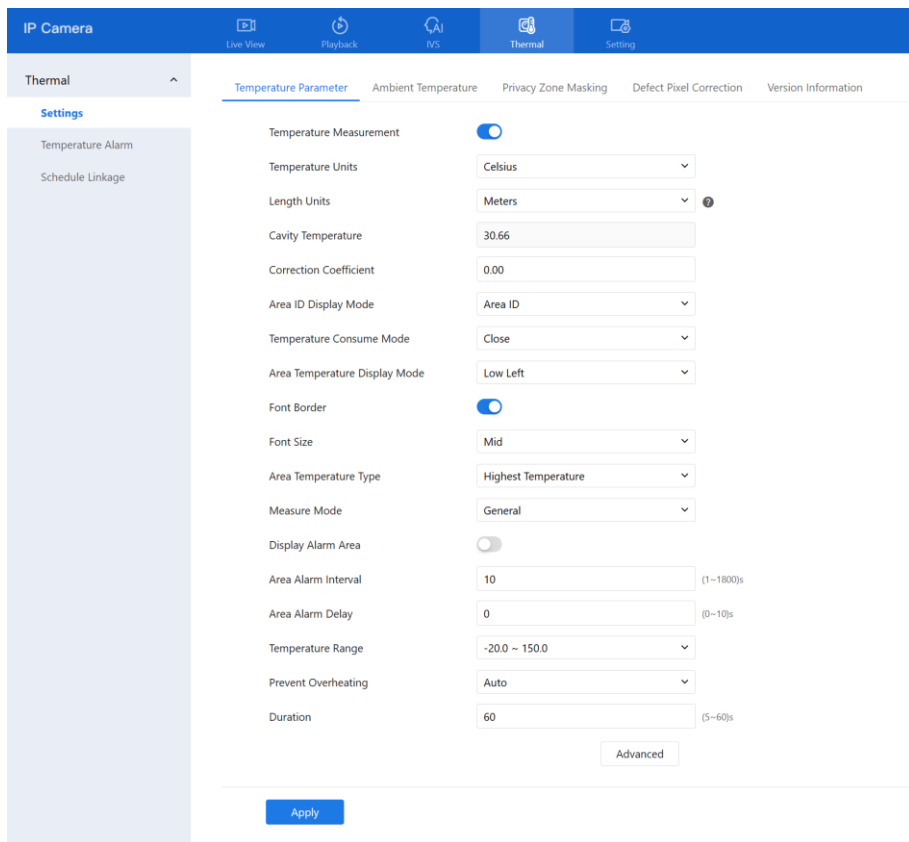

Step 2 Set the parameters according to Table 4-1.

Table 4-1 Temperature Parameters

Parameter	Description	Setting
Temperature Measurement	The default is enabling.	[Setting method] Enable or disable [Default value] Enable
Temperature Units	Celsius and Fahrenheit temperature units are available.	[Setting method] Select a value from the drop-down list box.

Parameter	Description	Setting
		[Default value] Celsius
Length units	Meters and feet length units are available.	[Setting method] Select a value from the drop-down list box. [Default value] Meters
Cavity Temperature	The cavity temperature of the camera.	N/A
Correction Coefficient	<p>The correction coefficient refers to the deviation between the measured object temperature and the actual temperature, which is the offset value. It ranges from -100 to 100.</p> <p>For example:</p> <ol style="list-style-type: none"> 1. The measured object temperature is 20, and the actual temperature is 20.5, so the correction coefficient should be 0.5. 2. The measured object temperature is 20, and the actual temperature is 19.5, so the correction coefficient should be -0.5. <p>NOTE</p> <p>The user should contact the technical support staff of our company at this condition to make sure to apply</p>	<p>[Setting method] Enter a value manually. [Default value] 0.00</p>
Area ID display mode	Two modes can be displayed, area ID and area name	<p>[Setting method] Select a value from the drop-down list box. [Default value] Area ID</p>
Temperature Consume Mode	Transfer temperature values or images to third-party platforms via SDK(Software development kit) protocol. You can get a custom SDK from the manufacturing	<p>[Setting method] Select a value from the drop-down list box. [Default value]</p>

Parameter	Description	Setting
	company if needed.	Close
Area Temperature Display Mode	The display position of temperature information on the live video image.	[Setting method] Select a value from the drop-down list box. [Default value] Low left
Font Border	Enable to bold the font	[Setting method] Enable or disable [Default value] Disable
Font size	Three font sizes can be chosen, small/mid/big	[Setting method] Enable or disable [Default value] Mid
Area Temperature Type	There are three types of area temperature.	[Setting method] Select a value from the drop-down list box. [Default value] Highest Temperature
Measure Mode	There are two types of measurement modes.	[Setting method] Select a value from the drop-down list box. [Default value] General
Display Alarm Area	Tick, the setting alarm area will display on live video.	[Setting method] Enable or disable [Default value] Disable
Area Alarm Interval	During the interval, the same alarm will only be sent once.	[Setting method] Enter a value manually ranges from 1 to 1800s. [Default value] 10

Parameter	Description	Setting
Area Alarm delay (0-10S)	The area alarm information will be delayed for setting time.	[Setting method] Enter a value manually ranging from 1 to 10. [Default value] 10
Temperature range	It depends on the device. Different devices have different modes, such as -20 °C -150°C.	[Setting method] Select a value from the drop-down list box.
Prevent Overheating	Open, if the temperature of the testing area is too high, you can enable it to prevent overheating function. The control cover will be laid down to keep the detector safe. There are two types, manual and auto.	[Setting method] Select a value from the drop-down list box.
Duration	Prevent over heat' mode is auto, the control cover will block for a duration of time automatically if overheated.	[Setting method] Enter a value manually ranging from 5 to 60s.

Figure 4-2 Advanced Interface

Advanced

Dimming Mode		<input style="width: 95%; border: 1px solid #ccc;" type="text" value="Auto"/>
Greater Prominent		<input type="checkbox"/>
Section Prominent		<input type="checkbox"/>
Less Prominent		<input type="checkbox"/>
Raw Data Upload Interval(F/S)		<input style="width: 95%; border: 1px solid #ccc;" type="text" value="1"/>
Mix Stream Mode		<input style="width: 95%; border: 1px solid #ccc;" type="text" value="Close"/>

Apply

Table 4-2 Advance Parameters

Parameter	Description	Setting
Dimming Mode	<p>There are auto and manual modes.</p> <p>Auto: It will show on the temperature item depending on the full-screen temperature.</p> <p>Manual: it will show on the manual value.</p>	<p>[Setting method] Select a value from the drop-down list box.</p> <p>[Default value] Auto</p>
Greater Prominent	<p>Enable that, the image will show the setting color if the temperature is higher than the set value.</p>	<p>[Setting method] Enter a value manually. Choose one color to show.</p>
Section Prominent	<p>Enable that, the image will show the setting color if the temperature is between minimum and maximum temperature.</p>	<p>[Setting method] Enter a value manually. Choose one color to show.</p>
Less Prominent	<p>Enable that, the image will show the setting color if the temperature is lower than the set value.</p>	<p>[Setting method] Enter a value manually. Choose one color to show.</p>

Parameter	Description	Setting
Raw Data Upload Interval(F/S)	Interval of uploading the raw data.	[Setting method] Select a value from the drop-down list box. [Default value] 1
Mix Stream Mode	This function is used for mixing thermal and visible imaging, if you want to adjust the location, please set at thermal channel “ Setting > Display > Pseudocolor” tab interface. There are close, mode 1 mode 2, and mode 3. The different models may have different displays; Please refer to the actual product.	[Default value] Close

Click **Apply** to save.

----**End**

4.1.2 Ambient Temperature

Usually, no customer configuration is required. The current ambient temperature needs to be configured only when the device has just been powered on but the user needs to measure the temperature immediately.

Choose **Thermal > Settings > Ambient Temperature**

Figure 4-3 Ambient Temperature

Temperature Parameter **Ambient Temperature** Privacy Zone Masking Thermal Mapping Defect Pixel Correction Version Information

Ambient Temperature

Self-adaptive Temperature

Apply

Table 4-3 Parameter of Ambient Temperature

Parameter	Description	Setting
Ambient Temperature	Environment temperature of the camera. When the camera is powered on for at least half an hour and the cavity temperature is stabilized, set the temperature. It is set as the environment temperature of the camera.	[Setting method] Enter the temperature of the ambient environment. [Default value] 25
Self-adaptive Temperature	Set the ambient temperature, and click “Apply”, the camera will get the value automatically.	---

Click **Apply** to save.

---End

4.1.3 Privacy Zone Masking

Privacy zone masking means that the camera will not detect the temperature of that area. The shield areas can be set up to eight areas.

Operation Procedure

Step 1 Choose **Thermal > Settings > Privacy Zone Masking**.

Figure 4-4 Privacy Zone Masking

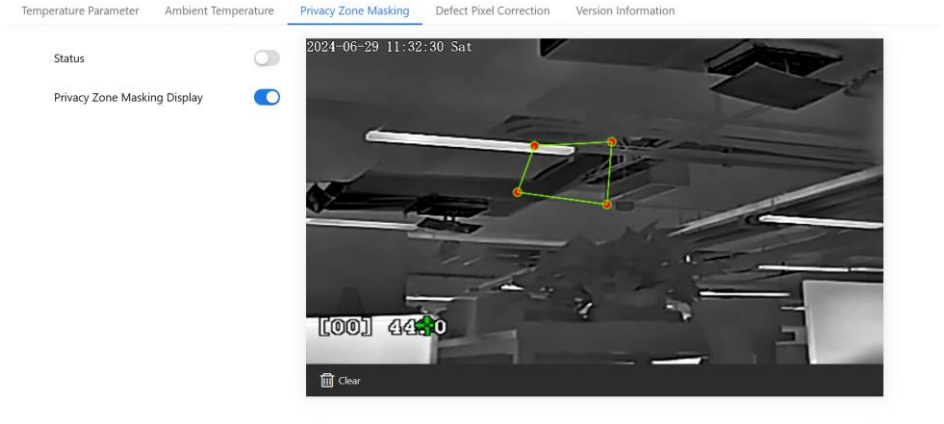

Apply

- Step 2 Enable the privacy zone masking.
- Step 3 Enable Show Privacy Zone Masking Display, then the setting shield will show on live video.
- Step 4 Click-left mouse button to set the area; Click-right mouse button to end the setting.
- Step 5 Click **Clear** to clear the setting area.
- Step 6 Click **Apply** to save.
- End

4.1.4 Defect Pixel Correction

Operation Procedure

- Step 1 Choose **Thermal > Settings > Defect Pixel Correction**.

The **Defect Pixel Correction** page is displayed, as shown in the figure.

If the image has a white dot as shown in the figure, the user can test the function to recover the defective pixel. Users should connect the technical support at this condition to make sure to apply.

Figure 4-5 Defect pixel correction

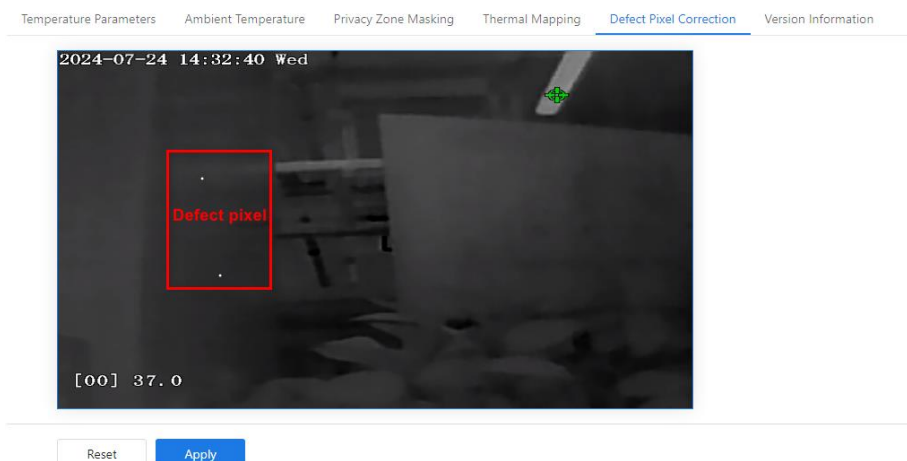

Step 2 Click the white point at the image, and click **Reset** to recover the defect pixel, as shown in Figure 4-6.

Figure 4-6 Recover Defect Pixel



Step 3 Click **Apply**. The message "Apply success" is displayed, and the system will save the settings.

---End

4.1.5 Version Information

Check the MCU version and MCU sequence number for easy traceability

4.2 Temperature Alarm

Operation Procedure

Step 1 Choose **Thermal > Temperature Alarm**.

The **Temperature Alarm** page is displayed, as shown in Figure 4-7.

Figure 4-7 Temperature Area and Alarm Configuration

The screenshot displays the 'Thermal' configuration page in the IP Camera web interface. The left sidebar shows 'Thermal' settings, including 'Settings', 'Temperature Alarm', and 'Schedule Linkage'. The main area is titled 'Alarm Configuration' and features a PTZ control panel and a live thermal video feed. The video feed shows a temperature of 43.3. Below the video, there are two configuration tables.

Table 1: Alarm Configuration

ID	Name	Type	Alarm Type	Warning Value	Alarm Value	Maximum Alarm ...	Duration(1-10)
<input checked="" type="checkbox"/>	Area0	Rectangle	Threshold ...	48	50	60.00	1.00
<input type="checkbox"/>	Area1	Point	Threshold ...	48	50	60.00	1.00
<input type="checkbox"/>	Area2	Point	Threshold ...	48	50	60.00	1.00
<input type="checkbox"/>	Area3	Point	Threshold ...	48	50	60.00	1.00
<input type="checkbox"/>	Area4	Point	Threshold ...	48	50	60.00	1.00
<input type="checkbox"/>	Area5	Point	Threshold ...	48	50	60.00	1.00
<input type="checkbox"/>	Area6	Point	Threshold ...	48	50	60.00	1.00

Table 2: Measurement Parameters

Emission Rate	Distance(m)	Reflectio...	Reflection Tempe...	IgnoreObject	Alarm	Masking	Group ID
0.95	15	<input type="checkbox"/>	50	None	<input type="checkbox"/>	<input type="checkbox"/>	None
0.95	15	<input type="checkbox"/>	50	None	<input type="checkbox"/>	<input type="checkbox"/>	None
0.95	15	<input type="checkbox"/>	50	None	<input type="checkbox"/>	<input type="checkbox"/>	None
0.95	15	<input type="checkbox"/>	50	None	<input type="checkbox"/>	<input type="checkbox"/>	None
0.95	15	<input type="checkbox"/>	50	None	<input type="checkbox"/>	<input type="checkbox"/>	None
0.95	15	<input type="checkbox"/>	50	None	<input type="checkbox"/>	<input type="checkbox"/>	None
0.95	15	<input type="checkbox"/>	50	None	<input type="checkbox"/>	<input type="checkbox"/>	None

Step 2 Set the parameters according to Table 4-4.

Table 4-4 Alarm configuration

Parameter	Description	Setting
Measure Mode	Set at temperature parameter interface. For the Preset mode, choose one preset, it will invoke the chosen preset, and the device moves to the preset position.	N/A
Enable ID	Tick the ID to enable the area measuring.	[Setting method] Tick
Name	Area name of temperature area.	[Setting method] Enter a value manually.
Type	Type of temperature area. ID 0 is the default rectangle area, which is full screen. It cannot be modified. Other IDs can be set as point, line, or polygon.	[Setting method] Select a value from the drop-down list box. [Default value] Rectangle/Point
Alarm Type	Temperature difference alarm: when the area's temperature difference (Highest temperature minus Average temperature) is over the setting value (Warning temperature or Alarm temperature), it will generate the alarm. Temperature rise alarm: In the duration time. If the rising temperature value is more than the set value (Warning temperature or Alarm temperature), it will generate the alarm. Temperature threshold alarm: when the temperature is higher than the threshold, the alarm will be triggered. Section Alarm: if the temperature value is within the set temperature range, it will generate the alarm.	[Setting method] Select a value from the drop-down list box. [Default value] Threshold alarm

Parameter	Description	Setting
Warning Value	The camera will trigger a warning alarm when the object's temperature reaches the warning value.	[Setting method] Enter a value manually. [Default value] 48
Alarm Value	The camera will alarm when the object temperature reaches the alarm value.	[Setting method] Enter a value manually. [Default value] 50
Maximum Alarm Value	At section alarm type, the device would not alarm when the temperature is higher than the maximum alarm value.	[Setting method] Enter a value manually. [Default value] 60.00
Duration (1-10S)	Choose a temperature rise alarm, and set the duration. The temperature value rises within the duration setting, the alarm is triggered successfully.	[Setting method] Enter a value manually. [Default value] 1.00
Emission Rate	The emission rate is the capability of an object to emit or absorb energy. The emission rate should be set only when the target is a special material.	[Setting method] Enter a value manually. [Default value] 0.95

Parameter	Description	Setting
Distance(m)	The distance between the camera and the target.	[Setting method] Enter a value manually. [Default value] 15  NOTE Enter the actual distance when the distance between the camera and the target is less than 15m. Enter 15 when the distance between the camera and the target is greater than or equal to 15m.
Reflection Temperature on	When there are some high-temperature objects on the scene, and the temperature reflects to the other object, you can enable this function to calibrate the temperature.	[Setting method] Tick to enable
Reflection Temperature	The temperature of high-temperature objects.	[Setting method] Enter a value manually. [Default value] 50.00
Ignore Object	Enable to shield the temperature of area capturing AI objects.	[Setting method] Select a value from the drop-down list box.
Alarm	Enable or disable the alarm output and linkage of the area.	[Setting method] Tick to enable the alarm.
Masking	Enable, the device will shield this area's temperature.	[Setting method] Tick to shield.

Parameter	Description	Setting
Group ID	<p>Different areas can be divided into the same group. The same group's areas will be merged calculated temperature difference alarm.</p> <p>The ID can be chosen into one of six groups or no group. The group will be alarm following the next rules:</p> <p>A=The highest temperature of groups (the highest temperature of N regions is the largest)</p> <p>B=Average temperature of groups (average temperature of N regions)</p> <p>WA=Warning value</p> <p>AA=Alarm value</p> <p>a. If $A-B \geq WA$, a temperature difference warning signal is generated ---> (the one with the largest difference between the N areas and the average temperature is the alarm area flashing)</p> <p>b. If $A-B \geq AA$, a temperature difference alarm signal is generated --> (the one with the largest difference between the N areas and the average temperature is the alarm area flashing)</p> <p>c. If the warning and alarm conditions are met at the same time, the alarm signal will be generated first.</p>	<p>[Setting method]</p> <p>Select a value from the drop-down list box.</p>

Step 3 Set temperature area.

1. Tick an area ID. Set the name.
2. Choose the type (point, line, polygon)
3. Press and hold the left mouse button, and drag in the video area to draw a temperature area, as shown in Figure 4-8. Right-click to finish the area selected.

Figure 4-8 Temperature Area Setting Interface



- Step 4 Click **Apply**, the message “Apply success” is displayed, and the temperature area is set successfully.

NOTE

ID 0 is the full screen; The area cannot be changed.



: The lowest temperature of the full screen.



: The highest temperature of the full screen.



: The lowest temperature in the area.



: The highest temperature in the area.

- Step 5 Delete a temperature area:
1. Select an area ID.
 2. Click **Clear**.
 3. Remove the tick of the area ID.
 4. Click **Apply**, the message “Apply success” is displayed, and the temperature area is deleted successfully.

- Step 6 Click **Apply**. The message "Apply success" is displayed, and the system will save the settings.

---End

4.3 Schedule Linkage

Operation Procedure

Step 1 Choose **Thermal > Schedule Linkage**.

There are seven types of alarm linkage, threshold alarm, threshold warning, temperature difference alarm, temperature difference warning, temperature section alarm, temperature rise alarm, and temperature rise warning.

The **Schedule Linkage** page is displayed, as shown in Figure 4-9.

Figure 4-9 Schedule Linkage

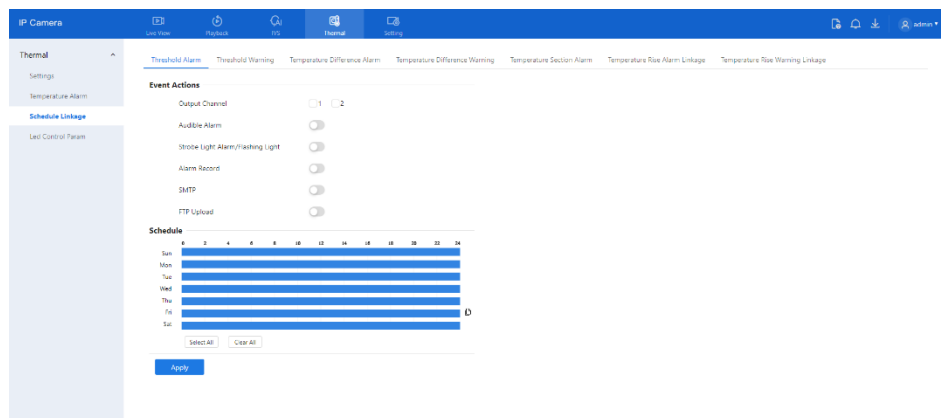

Step 2 Tick the output channel.

Step 3 Enable wanted linkage: “Output Channel” “Audible alarm”, “Alarm Record”, “SMTP”, and “FTP upload”.

Step 4 Set schedule linkage.

Method 1: Hold down the left mouse button, drag and release the mouse to select the deployment time 0:00-24:00 from Monday to Sunday.

Method 2: Click **Select All** to deploy all the time.

Method 3: Set one day, click  to copy to other days.

Figure 4-10 Copy

Copy:

All

Sun

Mon

Tue

Wed

Thu

Fri

Sat

OK

Delete schedule time: click **Clear All** to delete all time.

Click the set time, ~ click **Delete** to delete this time.

Step 5 The message "Apply success" is displayed, and the system will save the settings.

 **NOTE**

Figure 4-11 Audio file

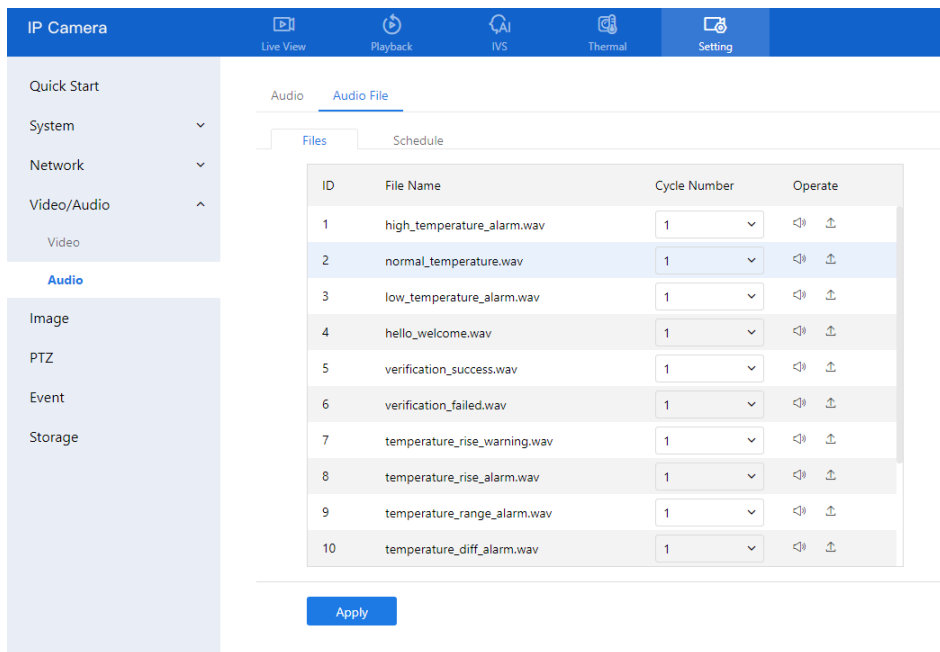

Users can set the audio file manually. Click  to upload the audio file(The type should be WAV, the size must be less than 250 Kb, and the bit rate should be 128 kbps.), as shown in Figure 4-12.

Figure 4-12 Upload audio file



----End

5 IVS Settings

On the IVS (intelligent video system) page, users can set deep learning (**AI multi-target**), intelligent analysis (**intrusion, smart motion, single line crossing, double line crossing, multi-loitering, wrong-way, enter area, leave area**), environmental safety analysis (**smoking, fire spot detection**), behavior analysis (**people counting**).

5.1 AI Multi-Target

Step 1 At **IVS > AI Multi-Target** interface, the user can enable full-body detection, and vehicle detection to detect the person and vehicle, as shown in Figure 5-1.

Figure 5-1 AI Multi-Target

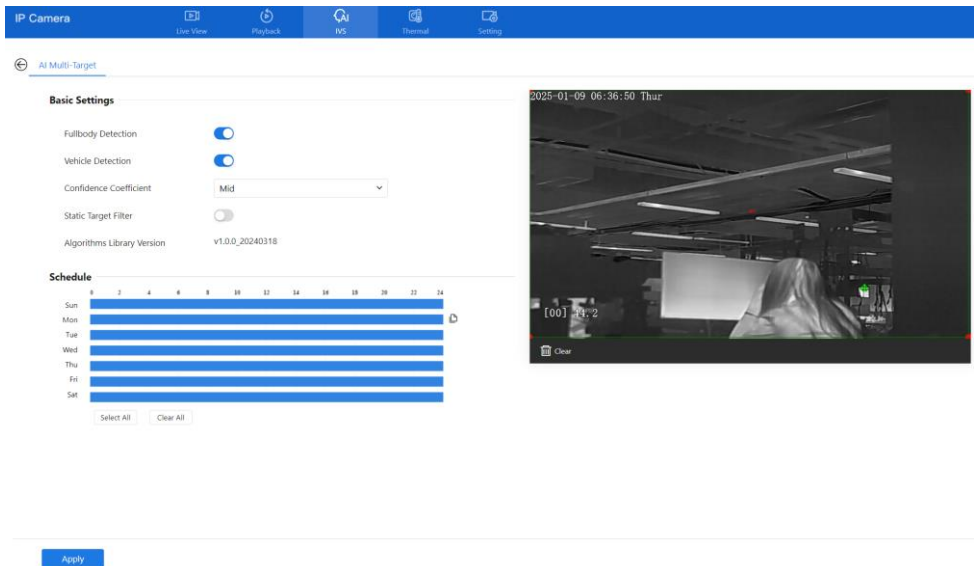

Step 2 Set the parameters of AI Multi-Target following as the Table 5-1.

Table 5-1 AI Multi-Target parameters

Parameter	Description	Setting
Full body detection	The camera will snap the whole body when someone appears in the live video. The detection	Enable

	frame is blue.	
Vehicle detection	The camera will snap the license when the vehicle appears in live video. The detection frame is yellow.	Enable
Confidence Coefficient	There are three types, such as high, mid, and low. The higher the confidence, the better the snap quality and the fewer snapshots.	Choose from the drop-down list.
Static Target Filter	If the target is static, the device will filter this target. For example, if a vehicle stops for a long time, the device will be filtered.	Enable

Step 3 Draw the detection area by using the mouse.

Step 4 To set the schedule, please refer to *Chapter 4.3 Step 4*.

Step 5 click “Apply” to save the settings.

---End

5.2 Intelligent Analysis

5.2.1 Intrusion

The Intrusion function refers to an alarm generated when target objects (such as person, vehicle, and both person and vehicle) enter the deployment area.

Procedure

Step 1 Select **IVS > Intelligent Analysis > Intrusion** to access the **Intrusion** interface, as shown in Figure 5-2.

Figure 5-2 Intrusion Setting Interface

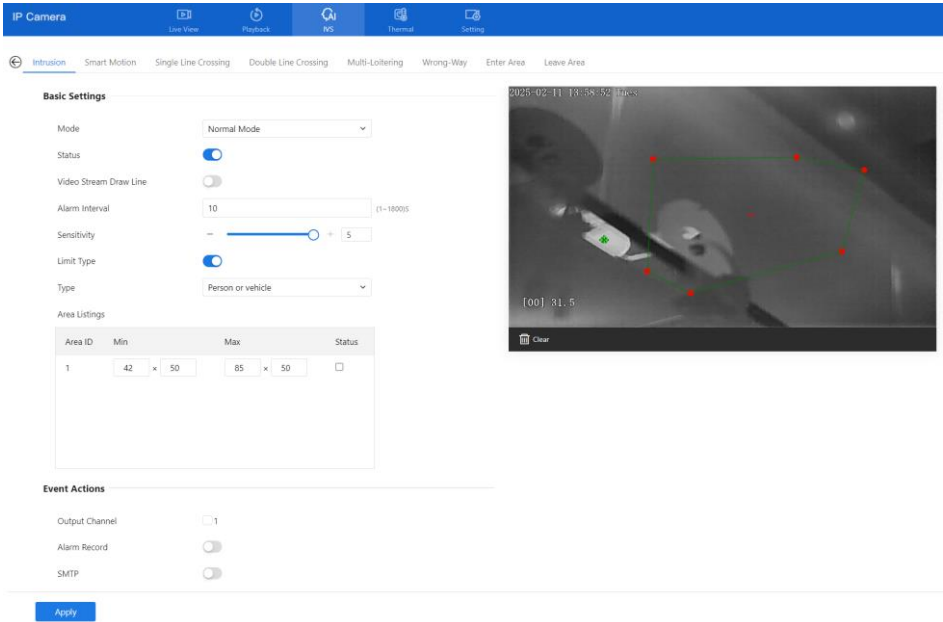

Step 2 Set all parameters of Intrusion. Table 5-2 describes the specific parameters.

Table 5-2 Intrusion Parameter Description

Parameter	Description	Setting
Mode	Normal mode and preset mode. Preset mode: choose one preset to set parameters on it.	[How to set] Choose from the drop-down list [Default value] Normal mode
Status	Enable the button to enable the alarm.	[How to set] Click Enable to enable. [Default value] OFF
Video Stream Draw Line	Enable the button, and the draw frame of detection will show in live video.	[How to set] Click to enable FTP Upload. [Default value] OFF

Parameter	Description	Setting
Alarm Interval	During the interval, the same alarm will only be sent once.	[How to set] Input a value [Default value] 10
Sensitivity	The sensitivity of detecting smoking, when the value is high, the alarm can be triggered easily, but the accuracy will be lower.	[How to set] Choose from the drop-down list [Default value] 5
Limit Type	Effective alarms are set based on target type, with options of Person or Vehicle, person, vehicle. When the device is used indoors, because of small space and large targets, to avoid wrong alarms being triggered by a person even if a vehicle is selected, it is recommended to set the target type to person for indoor use.	[How to set] Click to enable Limit Target Type. [Default value] OFF
Area Listing	When users set the areas, the area will show on the listing. If the area status is on, the min and max size will show on the area, drag the frame to move, and adjust the points of the frame to change size.	
Output Channel	If you check to set the Output Channel and the device is connected to an external alarm indicator, the alarm indicator signals when an alarm is triggered.	[How to set] Click to select an ID.
Audible alarm	After enabling Audible Warning and setting Audible Alarm Output, the built-in speaker of the device or connected external speaker plays warning sounds when an alarm happens. (set at the “ Setting > Video / Audio > Audio File ”)	[How to set] Click to enable the Audible alarm [Default value] OFF
SMTP	Enable the button to enable the SMTP server.	[How to set] Click to enable SMTP. [Default value] OFF

Parameter	Description	Setting
FTP Upload	Enable the button to enable File Transfer Protocol.	[How to set] Click to enable FTP Upload. [Default value] OFF

Step 3 Set a deployment area. Move the cursor to the drawing interface and click to generate a point, move the cursor to draw a line, and then click to generate another point. This is how a line is generated. In this way, continue to draw lines to form any shape, and right-click to finish the drawing.



NOTE

A drawn line cannot cross another one, or the line drawing fails.

Any shape with 32 sides at most can be drawn.

The quantity of deployment areas is up to 8.

Step 4 For set deployment time, please refer to *Chapter 4.3 Step 4*.

Step 5 Click **Apply** to save the settings.

---**End**

5.2.2 Smart Motion

Smart motion refers to the alert generated when a specified type of target (such as a person, vehicle, etc.) moves within the live video defense area.

Select **IVS > Intelligent Analysis > Smart Motion** to access the **Smart Motion** interface, as shown in Figure 5-3.

Figure 5-3 Smart Motion

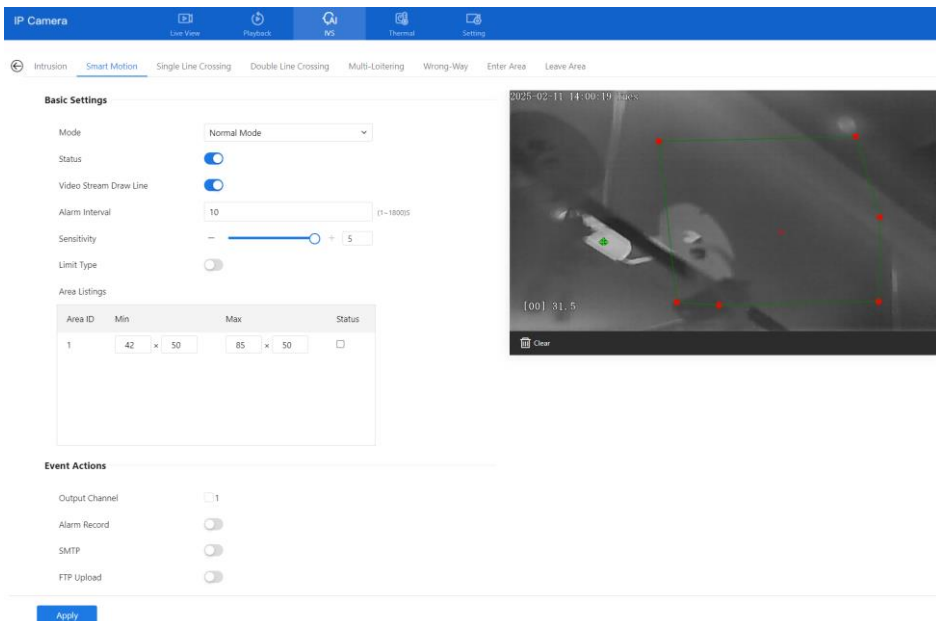

To set all parameters of smart motion, please refer to *Chapter 5.2.1*

5.2.3 Single Line Crossing

A Single Line Crossing is a line that is set at a concerned position within the monitored field of view and specifies the forbidden travel direction; An alarm is generated when the targets of specified types (such as person or vehicle) cross this line.

Procedure

- Step 1 Select **IVS > Intelligent Analysis > Single Line Crossing** to access the **Single Line Crossing** setting interface, as shown in Figure 5-4.

Figure 5-4 Single Line Crossing Setting Interface

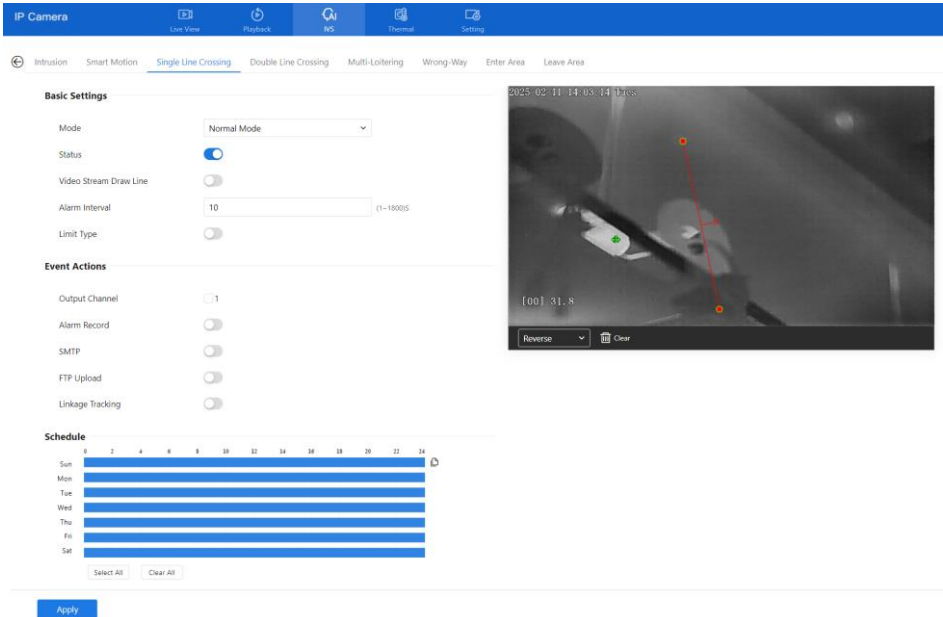

Step 2 Set all parameters of the Single Line Crossing, please refer to Table 5-2.

Step 3 Set a deployment area.

Draw a line: Move the cursor to the drawing interface, hold down the left mouse button, and move the cursor to draw a line. When you release the left mouse button, a Single Line Crossing is generated.

Setting a Single Line Crossing: Click a line (and the trip line turns red) to select the Single Line Crossing and set its direction as Positive, Reverse, or Bidirectional, or delete the selected line. You can also press and hold the left mouse button at the endpoint of a Single Line Crossing and move the mouse to modify the position and length of this Single Line Crossing. You can right-click to delete the Single Line Crossing.

Figure 5-5 Set Single Line Crossing Line



 **NOTE**

Try to draw the Single Line Crossing in the middle, because the recognition of a target takes time after the target appearance on the screen and an alarm is generated only when the object is recognized to have crossed the Single Line Crossing.

The Single Line Crossing which detects the person's foot as the recognition target cannot be too short, because a short Single Line Crossing tends to miss targets.

Step 4 Set deployment time, please refer to chapter 4.3 Step 4.

Step 5 Click **Apply** to save the settings.

---End

5.2.4 Double Line Crossing

Double Line Crossing refers to two lines that are set at a concerned special position within the field of view and specify the forbidden travel direction. When the targets of specified types (such as person or vehicle) move along the set travel direction and cross these lines in a certain order (line 1 followed by line 2) in pass max time, an alarm is generated.

Procedure

Step 1 Select **IVS > Intelligent Analysis > Double Line Crossing** to access the **Double Line Crossing** setting interface, as shown in Figure 5-6.

Figure 5-6 Double Line Crossing Setting Interface

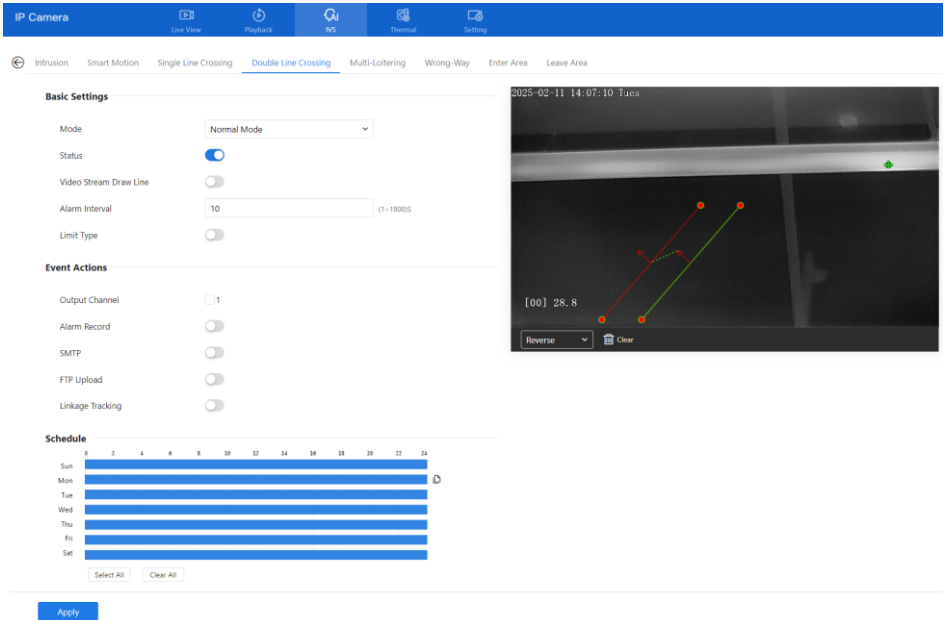

Step 2 Set all parameters of the Double Line Crossing. Please refer to *Chapter 5.2.1*

Step 3 Set a deployment area.

Draw a line: Move the cursor to the drawing interface, hold down the left mouse button, and move the cursor to draw two lines. When you release the left mouse button, two numbered virtual fences are generated. Choose either of the Double Line Crossing to set the direction to **Positive** or **Reverse**.

Set Double Line Crossing: Click one of the Double Line Crossing (and the virtual fence turns red) to select this virtual fence and set the direction to **Positive** or **Reverse**, or delete the selected line. You can also press and hold the left mouse button at the endpoint of a virtual fence and move the mouse to modify the position and length of this virtual fence. You can right-click to delete the Double Line Crossing.

NOTE

The two lines are in sequential order. An alarm is generated only when a target crosses virtual fence 1 and then virtual fence 2 within the set maximum passing time.

Try to draw a Double Line Crossing in the middle, because the recognition of a target takes time after the target appearance on the screen and an alarm is generated only when the object is recognized to have crossed the Double Line Crossing.

The Double Line Crossing which detects a person's foot as the recognition target cannot be too short, because a short Double Line Crossing tends to miss targets.

Step 4 Set deployment time, please refer to chapter 4.3 Step 4.

Step 5 Click **Apply** to save the settings.

----End

5.2.5 Multi-Loitering

Multi-loitering allows setting the shortest loitering time for multiple targets of the specified type (such as person or vehicle) within the deployment area in the field of view. When the loitering time of the multiple targets within this area meets the set shortest loitering time, an alarm is generated.

Select **IVS > Intelligent Analysis > Multi-Loitering** to access the **Multi-Loitering** setting interface, as shown in Figure 5-7.

Figure 5-7 Multi-Loitering

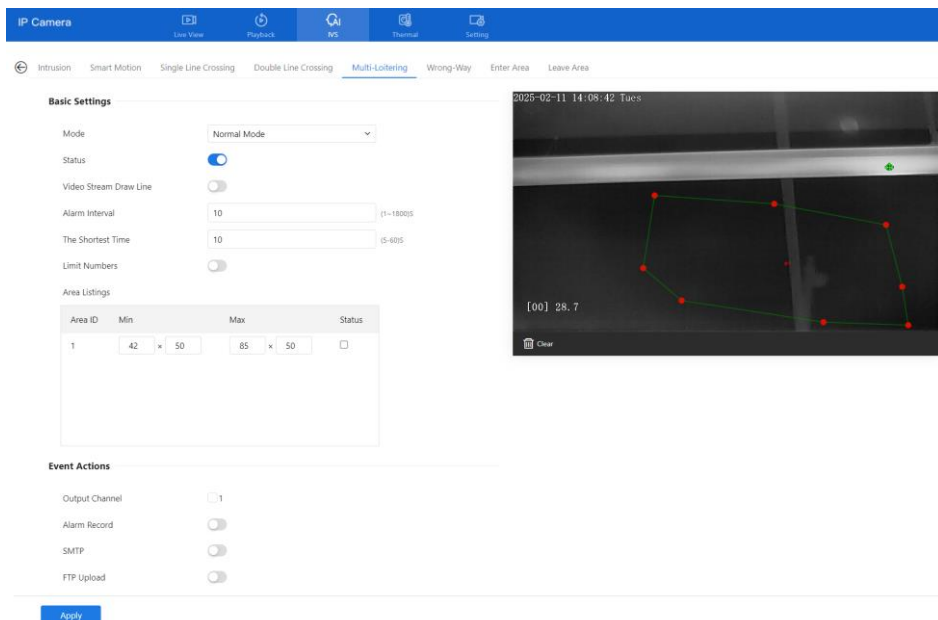

To set all parameters of multi-loitering please refer to *Chapter 5.2.1*

5.2.6 Wrong -Way

Wrong-way allows setting the travel direction criteria for a target within an area on the video screen.

If someone/something is moving in the opposite direction in an area, an alarm is generated.

Select **IVS > Intelligent Analysis > Wrong-Way** to access the **Wrong-Way** setting interface, as shown in Figure 5-8.

Figure 5-8 Wrong-Way

Basic Settings

Mode: Normal Mode

Status:

Video Stream Draw Line:

Alarm Interval: 10 (1-1800S)

Limit Type:

Area Listings:

Area ID	Min	Max	Status
1	42 × 50	85 × 50	<input type="checkbox"/>

Event Actions

Output Channel: 1

Alarm Record:

SMTP:

FTP Upload:

Linkage Tracking:

Set all parameters of wrong-way please refer to *chapter 5.2.1*

5.2.7 Enter Area

The enter area refers to an alarm generated when a target enters the deployment area at a valid time.

Select **IVS > Intelligent Analysis > Enter Area** to access the **Enter Area** setting interface, as shown in Figure 5-9.

Figure 5-9 Enter Area

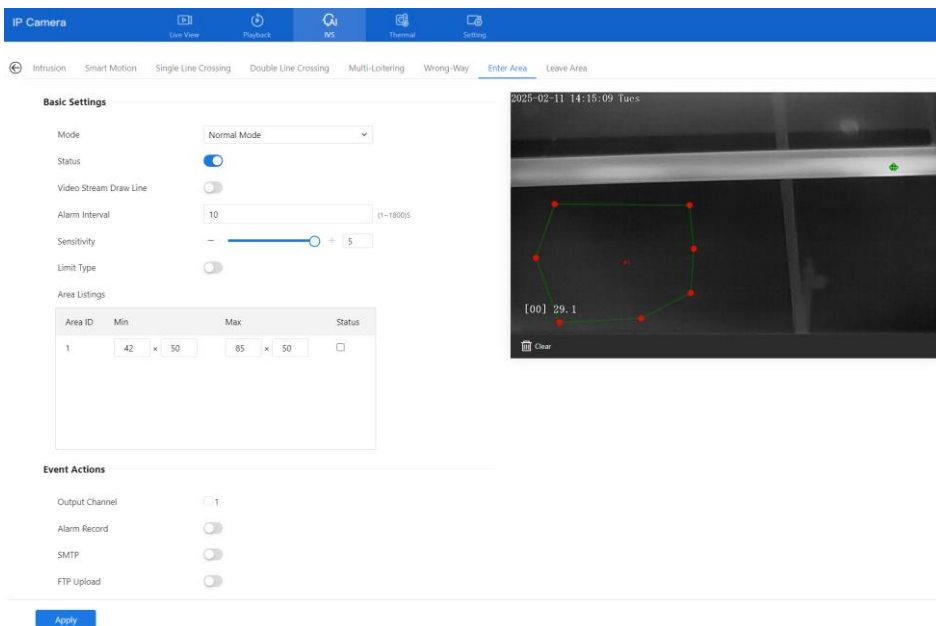

Set all parameters of entering area, please refer to chapter 5.2.1

5.2.8 Leave Area

The leave area refers to an alarm generated when a target leaves the deployment area at a valid time.

Select **IVS > Intelligent Analysis > Leave Area** to access the **Leave Area** setting interface, as shown in Figure 5-10.

Figure 5-10 Leave Area

Basic Settings

Mode: Normal Mode

Status:

Video Stream Draw Line:

Alarm Interval: 10 (1-1800S)

Sensitivity: 5

Limit Type:

Type: Person or vehicle

Area Listings

Area ID	Min	Max	Status
1	42 x 50	85 x 50	<input type="checkbox"/>

Event Actions

Output Channel: 1

Alarm Record:

SMTP:

2025-02-11 14:16:14 Tues

[00] 29.4

Clear

To set all parameters of leaving area, please refer to *Chapter 5.2.1*

5.3 Environmental Safety Analysis

At the advanced environmental Safety Analysis interface, users can set the parameters of smoking detection, smoke and flame detection, and fire spot detection. Enable the linkage actions, the alarm information can be sent to the user by the linkage.

5.3.1 Smoking Detection

Description

The smoking detection function refers to that an alarm is generated when someone is smoking or generating a spark at the deployment area.

Select **IVS > Environmental Analysis > Smoking Detection** to access the **Smoking Detection** interface, as shown in Figure 5-11.

Figure 5-11 Smoking detection interface

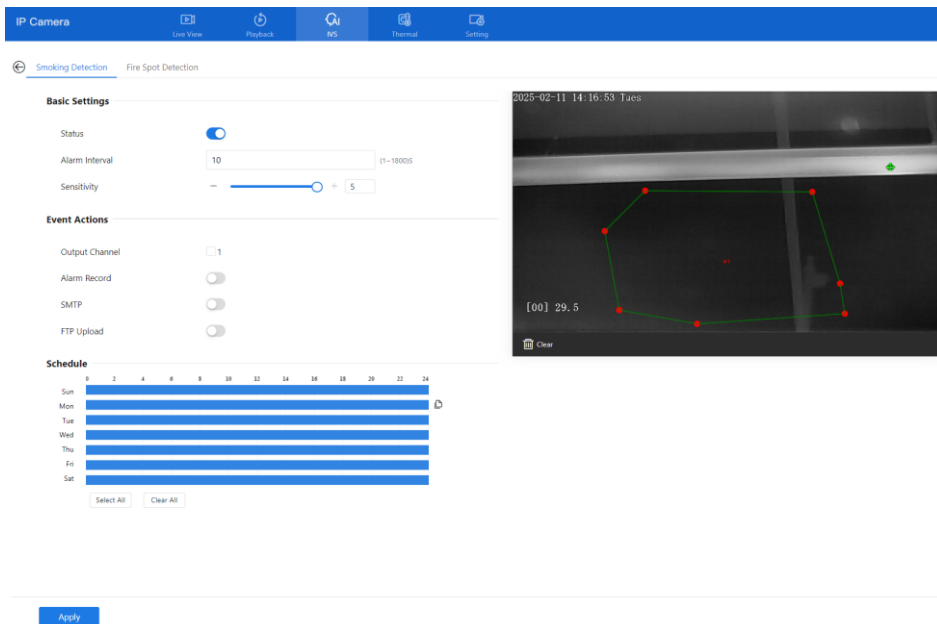

To set all parameters of smoking detection, please refer to *Chapter 5.2.1*

----End

5.3.2 Fire Spot Detection

Description

The fire spot detection function refers to that an alarm is generated when something is on fire at the deployment area.

Procedure

- Step 1 Select **IVS > Environmental Analysis > Fire Spot Detection** to access the **Fire Spot Detection** interface, as shown in Figure 5-12

Figure 5-12 Fire spot detection interface

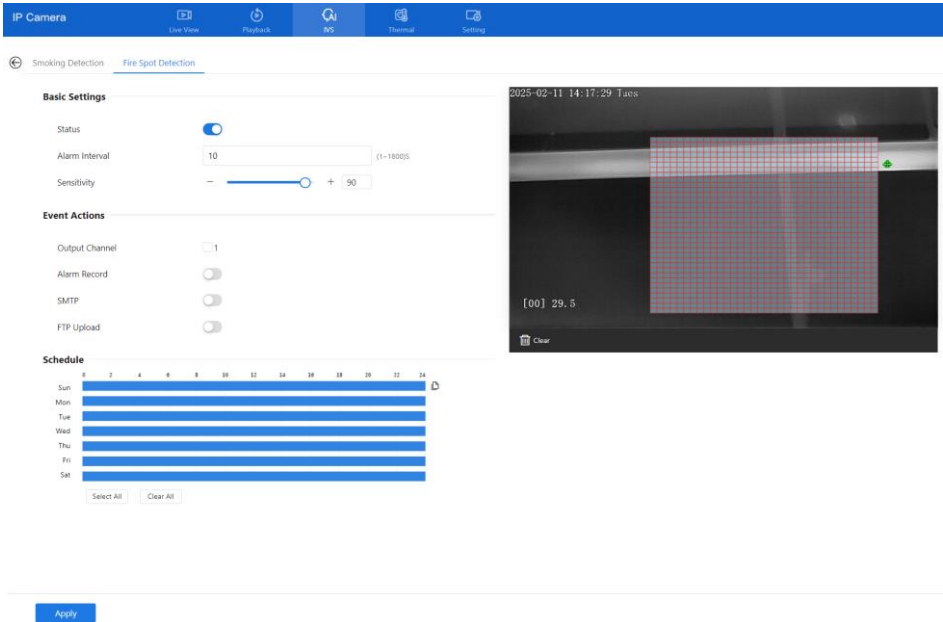

Step 2 Set all parameters of Fire Spot Detection, please refer to chapter 5.2.1

Step 3 Set a deployment area.

Use the mouse to draw a rectangular area, you can set several areas to deploy, as shown in Figure 5-13.

Figure 5-13 Set deployment area

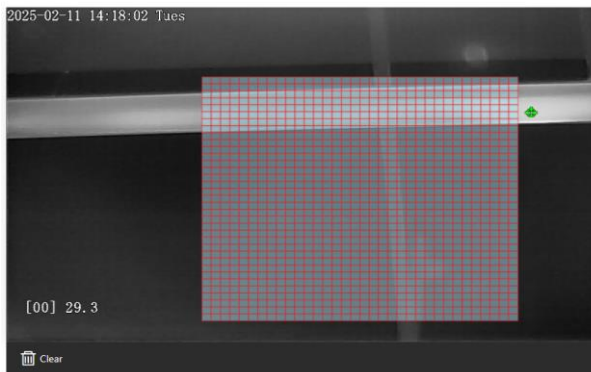

Step 4 Set deployment time, please refer to chapter 4.3 Step 4.

Step 5 Click **Apply** to save the settings.

---End

5.4 People Counting

Users can draw a line to count the number of people in the special area.

5.4.1 Set

Procedure

Step 1 Select **IVS > People Counting > Set** to access the **People Counting** setting interface, as shown in Figure 5-14.

Figure 5-14 People counting

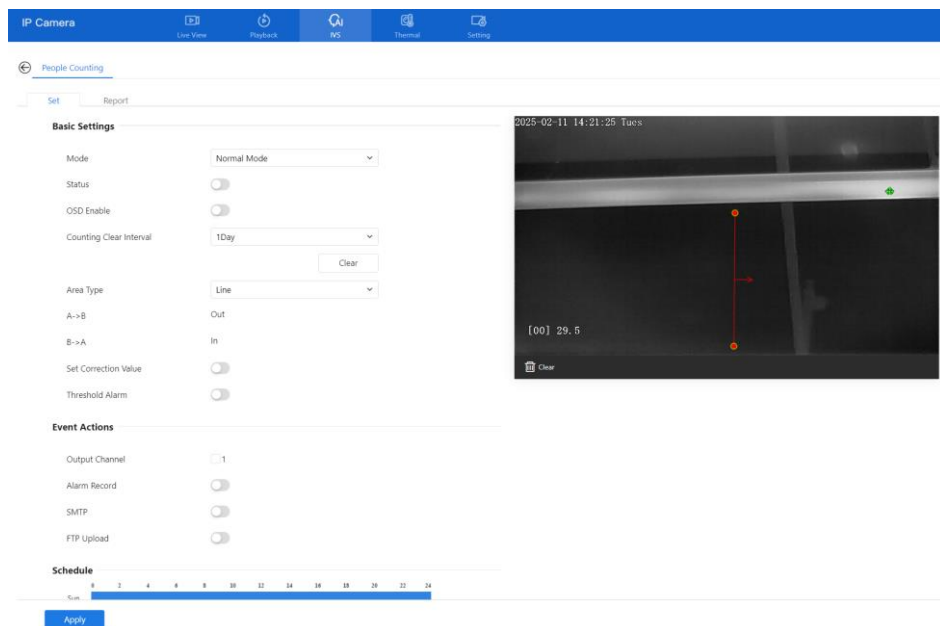

Step 2 Set all parameters of People Counting. Table 5-3 describes the specific parameters.

Table 5-3 Parameters of people counting

Parameter	Description	Setting
Mode	Normal mode or preset mode	[How to set] Choose from the drop-down list. [Default value]

Parameter	Description	Setting
		Normal mode
Status	Enable the button to enable the alarm.	[How to set] Click the button to enable. [Default value] OFF
OSD Enable	Enable the OSD, and the count data will show on the live video screen.	[How to set] Click Enable to enable. [Default value] OFF
Counting Clear Interval	The camera will clear counting data at the setting interval. Click the “Clear Counting”, clearing the data immediately.	[How to set] Choose from the drop-down list. [Default value] 1 Day
Area Type	Draw a line on the live video screen. The labels A and B indicate out and in.	[How to set] Choose from the drop-down list. [Default value] Line
Set Correction Value	Enable, and set the count correction value, it can be positive or negative. For example, if 30 people are entering the area before counting, input 30 to correct. If 30 people go out of the area, input -30.	[How to set] Enable /Input a value in the area box. [Default value] 0
Threshold Alarm	Enable, when the counting number reaches the threshold value, an alarm is triggered.	[How to set] Click Enable to enable. [Default value] OFF
Threshold	The threshold of enabling alarm.	[How to set] Enable /Input a value in the area box. [Default value] 1000
Output Channel	If you check to set the Output Channel and the device is connected to an external alarm indicator, the alarm indicator signals when an alarm is triggered.	[How to set] Click to select an ID.

Parameter	Description	Setting
Audible alarm	Enable, when an alarm occurs, it will play audio to the alarm. Choose the audible alarm file (set at the “ Configuration > Alarm > Audible Alarm Output ”).	[How to set] Click to enable the Audible alarm [Default value] OFF
SMTP	Enable the button to enable the SMTP server. The parameters of SMTP can be set at Configuration > Network Service > SMTP interface.	[How to set] Click to enable SMTP. [Default value] OFF
FTP Upload	Enable the button to enable File Transfer Protocol. The parameters of FTP can be set at Configuration > Network Service > FTP interface.	[How to set] Click to enable FTP Upload. [Default value] OFF

Step 3 Set a deployment area.

Move the cursor to the drawing interface and click to generate a point, move the cursor to draw a line, and then click to generate another point. This is how a line is generated. In this way, continue to draw lines to form any shape, and right-click to finish the drawing.

Step 4 Set deployment time.

Step 5 Click **Apply** to save the settings

----**End**

5.4.2 Report

At the people counting report interface, you can view the data of people counting by setting the query condition (choose the detailed time at the date’s pop-up window). There are three modes to show the data, such as line chart, histogram, and list, as shown in Figure 5-15.

Figure 5-15 Report of people counting

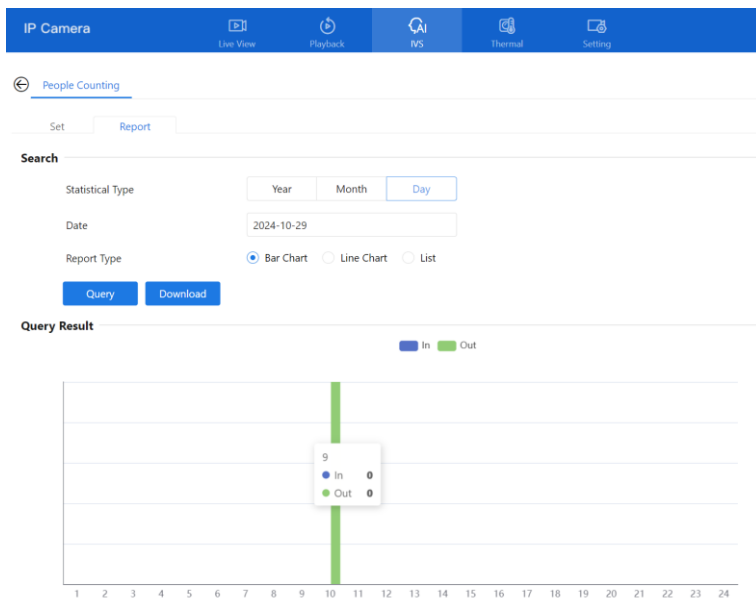

Click “Download” to download the query result.

Choose the mode of showing results, such as line chart, histogram, and list.

Click “Query” to query the data of people counting.

The data result can be saved to the local folder.

----End

6 PTZ Function Settings

6.1 PTZ Control function

Operation Description

PTZ Control function is only available to a camera with an external PTZ and a High-Speed Dome with PTZ function.

PTZ Control

When browsing Live videos shot by a dome camera or a camera connected to an external PTZ, you can control the PTZ to view Video shots in different directions.





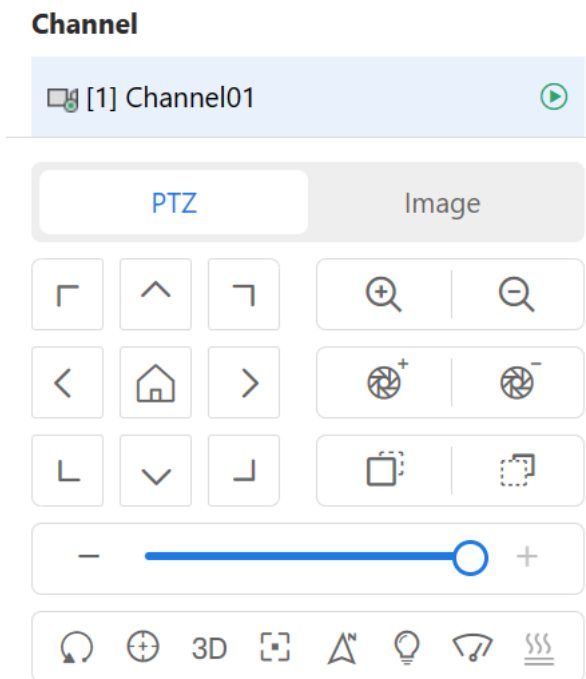







In the PTZ control area, you can click 8 arrow keys to move the PTZ in eight directions, as shown in Figure 6-1.

Figure 6-1 PTZ control zone



It may also control the iris, zoom, and focus of the camera lens through other buttons in the PTZ control zone. The functions of each button are as shown in Table 6-1.

Table 6-1 Descriptions of PTZ buttons

Button	Description
Arrow	Click the arrows to move the PTZ in eight directions.
Home	Click  to go home position.
Zoom	Click  to adjust the surveillance range of the front-end lens.
Iris	Click  to adjust the size of the front-end iris.
Focus	Click  to adjust the focus of the front-end lens.
Speed	Drag the slider on  to adjust the rotational speed of the PTZ.
	PTZ reset, click to reset the PTZ settings.
	PTZ self-test, click to self-test the PTZ rotate.
3D	Click  to operate the lens directly, zoom +/-zoom- the area, or move the focus point.
	Click to focus Lens automatically once.
	Indicates that the direction of the camera is north when the user clicks.
	Click on the light of the optical channel, and click again to off.
	Click to open the wiper, and click again to close the wiper.

---End

6.2 PTZ configuration

6.2.1 PTZ setting

The PTZ configuration interface is displayed on the Live Video page, under the part of PTZ control, as shown in Figure 6-2.

Figure 6-2 PTZ configuration

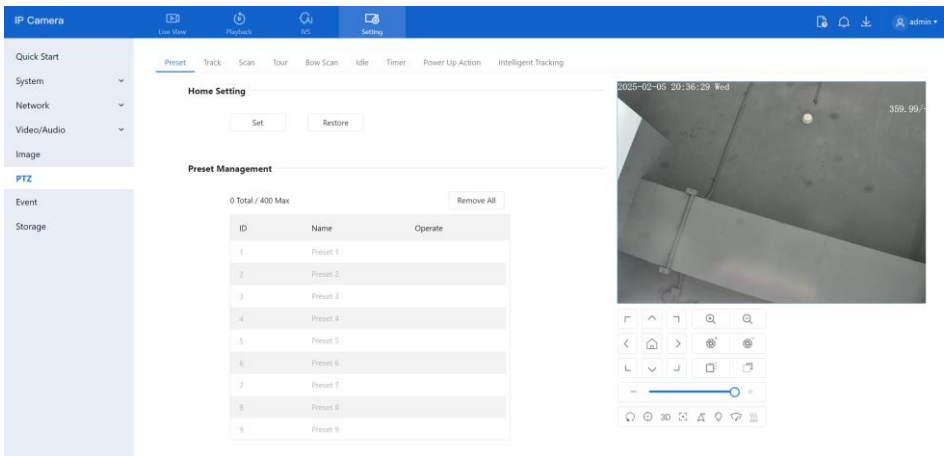
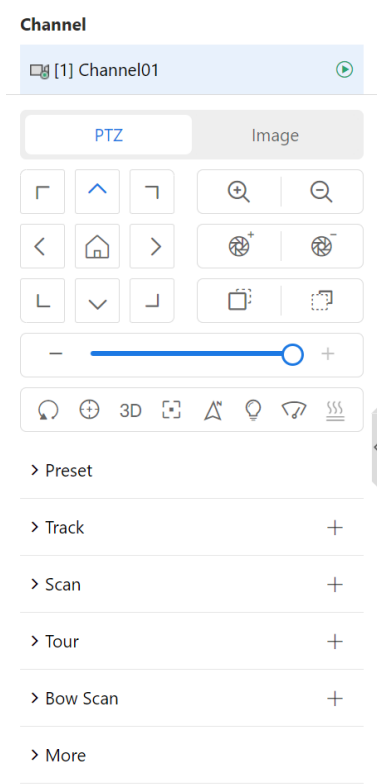

- Through this interface, you can perform the following operations:
- Add, Delete, and Apply a Preset, Track, Scan, Tour, and Bow Scan.
- Set and enable Idle.
- Set the home position.
- Set the direction to due north.
- Any direction can be set as the reference due north.
- Configure Timer.

---End

6.2.2 Configure and Apply Home

You can set any point as home, the default Home is the 0.00/90.0/1X coordinate. Click



to go home position directly.

Step 1 Click **Home**.

The **Home** page is displayed as shown in Figure 6-3.

Figure 6-3 Home configuration

Home Setting



Step 2 Adjust the PTZ keyboard to operate the lens.

Step 3 Click **Set** to set home. Click **Restore** to restore the default home.

Step 4 Click  invoke home.

---End

6.2.3 Configure and Apply Preset

You can configure preset positions and quickly rotate the camera to preset position by applying the preset.

Operation procedure

Step 1 Click **Preset** in the PTZ configuration area, the add preset list is displayed, as shown in Figure 6-4.

Figure 6-4 Preset configuration

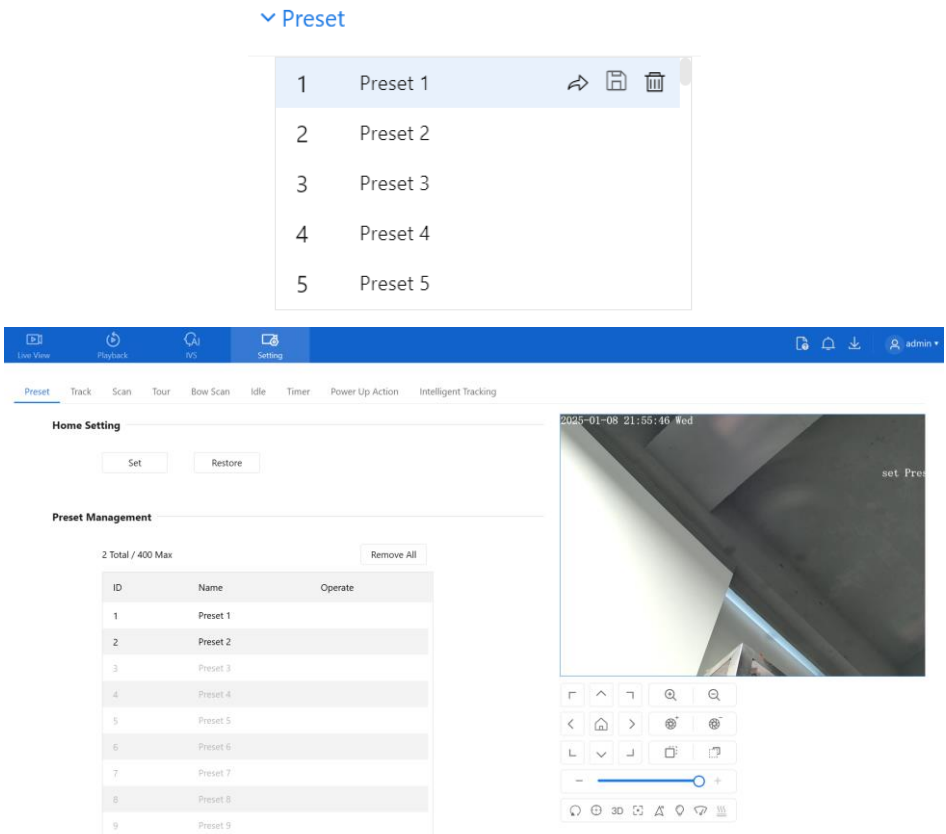

Step 2 Operate your PTZ to the position you want, then click the save icon , and the preset be created.

Step 3 Choose the preset you created, and click the preset name, you can modify the preset name. Please remember to save it after you change it.

Step 4 If you want to delete a preset, move your mouse to the preset you want to delete, and click the delete icon , and the preset be deleted. There are no tips for your delete operation, so be careful to do this.

Select a preset position from the **Preset** list to invoke the preset position. Click  icon to invoke.



NOTE

The special presets:

Set No.64 preset, the PTZ functions restore to factory settings.

Invoke the No.92 preset, and set the start point of scan.

Invoke the No.93 preset, and set the end point of scan.

Invoke No.97 preset, it will invoke SCAN 1.

Set No.97 preset, view the version of MCU and chip.

Invoke No.99 preset, scan by rotating 360°.

Invoke the No.250 preset, and enable the MCU temperature.

Invoke No.251 preset, and disable the MCU temperature.

Set No.252 preset, the PTZ parameters will be restored to factory settings.

Invoke 103 preset, the brush works once, this function is only for PTZ cameras with brush.

----End

6.2.4 Configure and Apply Tracks

You can record a track to allow the camera to repeatedly rotate based on the preset track.

Operation procedure

- Step 1 Click **Track** in the PTZ configuration area, the add track page is displayed as shown in Figure 6-5.

Figure 6-5 Add track

Preset **Track** Scan Tour Bow Scan Idle Timer Power Up Action Intelligent Tracking

Add Track



ID

Name

Scan Management

0 Total / 6 Max

ID	Name	Operate
1	Track 1	
2	Track 2	
3	Track 3	
4	Track 4	
5	Track 5	
6	Track 6	

- Step 2 Select a track ID from the Add Track box, and enter the track name.
- Step 3 Click **Start**, then use eight arrow keys in the **PTZ control** area to configure a track.
- Step 4 Click **End** to finish the track setting.
- Step 5 Select the track name from the Tracklist and click  to apply the track. If you want to delete the track, move your mouse to the track you want to delete, and click the delete icon , and the track be deleted.

 **NOTE**

Up to 6 Tracks can be configured.

---End

6.2.5 Configure and Apply Scan

You can configure a Scan to rotate the camera between two positions by applying the Scan.

If the two coordinates need to rotate at an angle of less than 180 ° clockwise, and more than 180 ° counterclockwise, the large arc will rotate; If that angle is a clockwise rotation of more than 180 ° and counterclockwise rotation of less than 180 °, then the small arc will rotate.

Operation procedure

Step 1 Click **Scan** in the PTZ configuration area, and the add Scan page is displayed, as shown in Figure 6-6.

Figure 6-6 Add scan

Add Scan

ID: 1
Name: Scan1
Stop Time: 0 (0-255)s

Start End



Scan Management

0 Total / 12 Max Remove All

ID	Name	Operate
1	Scan 1	
2	Scan 2	
3	Scan 3	
4	Scan 4	
5	Scan 5	
6	Scan 6	
7	Scan 7	
8	Scan 8	
9	Scan 9	

Step 2 Select Scan ID (such as 1) from the Add Scan box and enter the name of the scan.

Step 3 Click **Start**, then use eight arrow keys in the **PTZ control** area to configure two positions, set the stop time, and then click **End** to complete adding a scan.

Step 4 Select the Scan from the Scan list and click  to apply the scan. If you want to delete the scan, move your mouse to the scan you want to delete, and click the delete icon , and the scan be deleted. The scan name supports to modify.

---End

6.2.6 Configure and Apply Tour

You can configure a tour to rotate the camera between presets set by PTZ.

Operation procedure

Step 1 Click **Tour** in the PTZ configuration area, and the add tour page is displayed, as shown in Figure 6-7.

Figure 6-7 Add tour

The screenshot shows the PTZ configuration interface with the 'Tour' tab selected. The 'Add Tour' section includes a dropdown menu for 'ID' (set to 2), a text input for 'Name', and a table with columns 'ID', 'Preset', 'Time(S)', and 'Speed'. Below the table is a 'Save' button. The 'Tour Management' section shows '1 Total / 12 Max' and a 'Remove All' button, followed by a table listing tours 3 through 8.

ID	Preset	Time(S)	Speed

ID	Name	Operate
3	Tour 3	
4	Tour 4	
5	Tour 5	
6	Tour 6	
7	Tour 7	
8	Tour 8	

Step 2 Select Tour ID (such as 2) from the Add Tour box, and enter the tour name.

Step 3 Select the first required position preset from the **preset** drop-down list box.

Step 4 Input the values from the **Time** area box to set the time to stay in this position preset. (0 sec~ 255 sec).

Step 5 Click + to add the next position preset from the preset drop-down list box on the page; then input the values from the Time area box to set the time to stay in the next position preset. (0 sec~ 255 sec).

Step 6 Click **the Save** button to begin setting the tour.

Step 7 Select a tour name and preset from the tour and preset drop-down list box, and then click  to apply the tour.

----End

6.2.7 Configure and Apply Bow Scan

You can configure a Bow Scan to apply rotation at the setting step angle, the camera between two positions by applying the Scan.

Operation procedure

Step 1 Click **Bow Scan** in the PTZ configuration area, and the Bow Scan page is displayed, as shown in Figure 6-8.

Figure 6-8 Bow Scan configuration

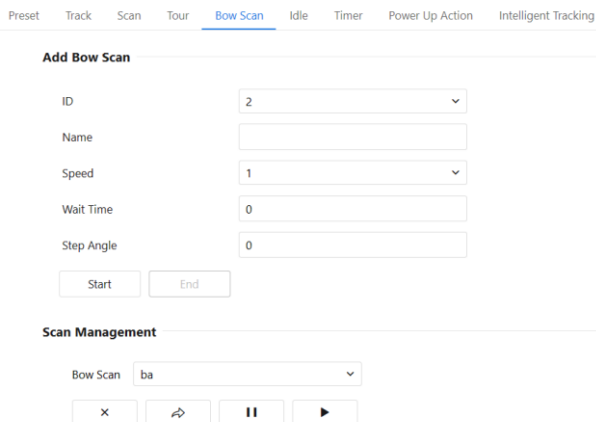

Step 2 Select Scan ID (such as 1) from the Add Scan box and enter the name of the scan.

Step 3 Enter the PTZ Speed, Wait Time, and Step Angle.

Step 4 Click **Start** to set the start position, then use eight arrow keys in the **PTZ control** area to let the PTZ turn to the position you want, click **End** to complete adding the scan.

Step 5 Select the Scan from the Bow Scan list and click  to apply the scan. If you want to delete the scan.

----End

6.2.8 Configure and Apply Idle

You can configure an idle to apply preset, Scan, Track, or Tour regularly.

Operation procedure

Step 1 Click **Idle** in the PTZ configuration area, and the idle page is displayed, as shown in Figure 6-9.

Figure 6-9 Idle configuration

Step 2 Click the Enable button to let the function go working first, and select a monitor type from the **Type** drop-down list box. Monitor type can choose preset, Scan, track, tour.

Step 3 Select a name from the **Name** drop-down list box, the name depends on what you choose in the type list.

Step 4 Input a value from the **Time** area box. Be careful the Time unit is minutes here.

Step 5 Click **Apply** to complete adding an idle. The PTZ camera will trigger the idle action if the PTZ is without any operation.

---End

6.2.9 Configure Timer

Operation procedure

Step 1 Click **Timer** in the PTZ configuration area, and the set timer page is displayed, as shown in Figure 6-10.

Figure 6-10 Set timer

[Preset](#) [Track](#) [Scan](#) [Tour](#) [Bow Scan](#) [Idle](#) **[Timer](#)** [Power Up Action](#) [Intelligent Tracking](#)

Status

Timer Mode

Time List

ID	Begin/End Time	PTZ Type	Name	Operate
1	<input type="text" value="00:00"/> ~ <input type="text" value="00:00"/>	<input type="text"/>	<input type="text"/>	<input type="text"/>
2	<input type="text" value="00:00"/> ~ <input type="text" value="00:00"/>	<input type="text"/>	<input type="text"/>	<input type="text"/>
3	<input type="text" value="00:00"/> ~ <input type="text" value="00:00"/>	<input type="text"/>	<input type="text"/>	<input type="text"/>
4	<input type="text" value="00:00"/> ~ <input type="text" value="00:00"/>	<input type="text"/>	<input type="text"/>	<input type="text"/>
5	<input type="text" value="00:00"/> ~ <input type="text" value="00:00"/>	<input type="text"/>	<input type="text"/>	<input type="text"/>
6	<input type="text" value="00:00"/> ~ <input type="text" value="00:00"/>	<input type="text"/>	<input type="text"/>	<input type="text"/>
7	<input type="text" value="00:00"/> ~ <input type="text" value="00:00"/>	<input type="text"/>	<input type="text"/>	<input type="text"/>
8	<input type="text" value="00:00"/> ~ <input type="text" value="00:00"/>	<input type="text"/>	<input type="text"/>	<input type="text"/>

- Step 2 Select the timer mode.
- Step 3 Select the required begin time at the **Begin Time** drop-down list box, and then select the required end time at the **End Time** drop-down list box.
- Step 4 Select the required monitor type at the PTZ type drop-down list box, you can select preset, Scan, Track, Tour, or Cancel in the box, and then select a specific from the **Name** drop-down list box. (for example preset, 1).
- Step 5 Repeat Step 3 and Step 4 to add more required time.
- Step 6 Click **Apply** to complete the timer setting.

---End

6.2.10 Configure Power UP Action

The camera will perform the selected PTZ type and name when the camera reboots and the reboot action is enabled.

- Click the reboot action button to enable the reboot action.
- Set the PTZ Type and name from the drop-down list box.
- Click Apply to finish the reboot set.

Figure 6-11 Power up action

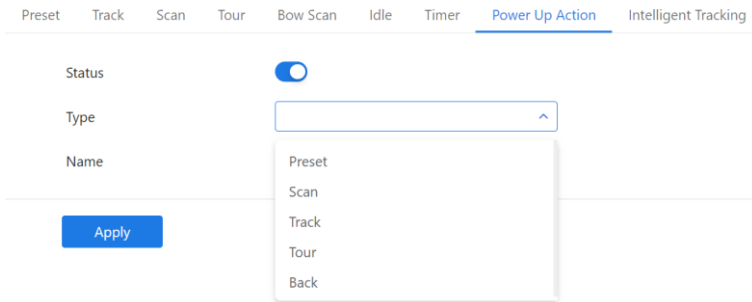

---End

6.2.11 Configure Intelligent Tracking

Description

This function is only used for high-speed domes.

Intelligent tracking can recognize the basic features such as the position, shape, contour, and color of the target with a special algorithm. After comparing and matching with images for each frame, the positions of the target in each frame of the video image are generated, and the motion track of the target is generated. The method performs a real-time monitoring of targets and automatically controls the gimbal to track moving objects. The automatic target tracking function is that the dome camera can continuously track the moving target of the pre-made scene, and automatically adjusts the camera zoom focus according to a moving target distance, and the dome automatically returns to the preset scene when the moving target disappears.

Procedure

- Step 1 Choose **Setting > PTZ > Intelligent Tracking** to access the Intelligent Tracking setting interface, and enable the intelligent tracking function, as shown in Figure 6-12.

Figure 6-12 Intelligent tracking page

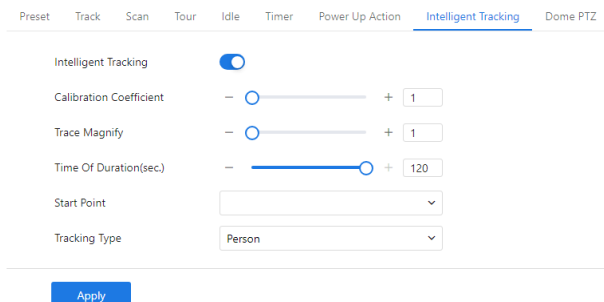

Step 2 Set all parameters for intelligent tracking. Table 6-2 describes the specific parameters.

Table 6-2 Parameters of intelligent tracking

Parameter	Description	Setting
Intelligent Tracking	Click the button to enable the intelligent tracking	[How to set] Click the button on. [Default value] OFF
Calibration Coefficient	It is equivalent to a control coefficient, and real-time tracking doubling rate nonlinear positive correlation; Usually the higher the installation height, the greater the calibration coefficient value; it ranges from 1 to 30.	[Setting method] Drag the slider. [Default value] 1
Trace Magnify	It is the value of lens zoom, which has a large influence on the real-time tracking magnification; it ranges from 0 to 30.	[Setting method] Drag the slider. [Default value] 7

Time of Duration (sec.)	The maximum time of a tracking period ranges from 0 to 300 s.	[Setting method] Drag the slider. [Default value] 120
Start Point	At the start point of the tracking, you can choose the preset or none. The preset should be set in advance.	[Setting method] Choose from the drop-down list. [Default value] None
Tracking Type	Choose the tracking type, person, or vehicle.	[Setting method] Choose from the drop-down list. [Default value] Person

Step 3 Click **Apply**. The message "Apply success!" is displayed, and the system will save the settings.

---End

6.2.12 Dome PTZ

Description

The device is connected to 485 keyboards, users can use the keyboard to control the cameras' PTZ menu.

Procedure

Step 1 Choose **Setting > PTZ > Dome PTZ**.

The **Dome PTZ** page is displayed, as shown in Figure 5-12.

Figure 6-13 Dome PTZ page

PTZ Address

[Apply](#)

Step 2 Input the PTZ address, the default is 1.

Step 3 Click **Apply**.

The message "Apply success!" is displayed, and the system will save the settings.

---**End**

7 Optical Channel

7.1 Image Display

7.1.1 Access the Display Settings

Operation Procedure:

Step 1 Choose **Setting > Quick Start > Display**.

Figure 7-1 Display settings of the optical light channel page

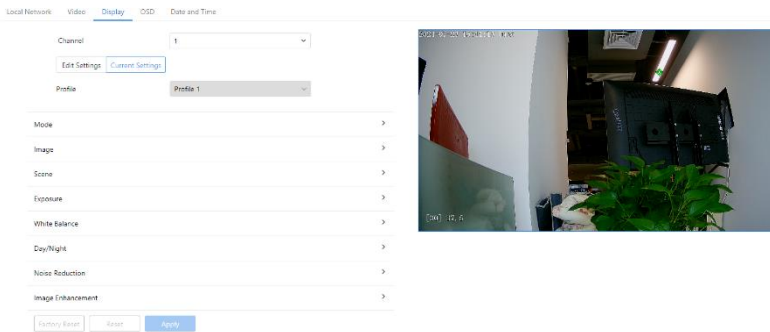

Step 2 Choose **Edit Settings** on the Mode item to set the parameters. You can set four profiles.



NOTE

All image settings can be modified in edit mode.

Factory Reset: All parameters will be restored to the factory settings.

Reset: the settings will be recovered to the last settings.

---End

7.1.2 Mode

Operation procedure:

Step 1 Choose **Setting > Quick Start > Display > Mode** tag on the display interface and the Mode page is displayed, as shown in Figure 7-2.

Figure 7-2 Mode page

Mode

Switch Mode: None

Start Time: 00 : 00

End Time: 24 : 00

Step 2 Choose Switch Mode, there are three modes to be chosen, none, time mode, and D/N linkage mode.

None: choose which profile, and it will execute that always.

Time mode: it will execute the profile through the setting start time and end time. The profile is set at a different time, it will switch at time.

D/N linkage mode: when the Day/Night is set to Auto, when it is Day mode which executes Profile 1; When it is Night mode which executes Profile 2; The specific switching conditions usually depend on the strength of the ambient light, and the camera automatically judges and switches modes through its built-in light sensor.

Step 3 Set the start time and end time.

Step 4 Click **Apply** to save the setting.

---End

7.1.3 Image Setting

Step 1 Choose **Setting > Quick Start > Display > Image** tag on the display interface, Figure 7-3 shows the image setting interface.

Figure 7-3 Image setting page



Step 2 Set the parameters according to Table 7-1.

Table 7-1 Parameters of image settings

Parameter	Description	Setting
Brightness	It indicates the total brightness of an image. As the value increases, the image becomes brighter.	[Setting method] Drag the slider. [Default value] 50
Saturation	It indicates the color saturation of an image. As the value increases, the image becomes more colorful.	[Setting method] Drag the slider. [Default value] 50
Sharpness	It indicates the clearness of an image. As the value increases, the image becomes more clearer.	[Setting method] Drag the slider. [Default value] 50
Contrast	It indicates the contrast between the bright part and the dark part of an image. As the value increases, the contrast increases.	[Setting method] Drag the slider. [Default value] 50

Step 3 Click **Apply** to save the setting.

---End

7.1.4 Scene Mode

Step 1 Choose **Setting > Quick Start > Display > Scene** tag on the display interface, Figure 7-4 shows the **scene mode** interface.

Figure 7-4 Scene mode page

Scene ▼

Scene

Mirror

Tip: Please Update Motion Detection, Privacy Mask, Intelligent Analysis, ROI and OSD Area Settings After [Corridor Mode]/[Mirror] was Changed.

Step 2 Set the parameters according to Table 7-2.

Table 7-2 Parameters of FFC

Parameter	Description	Setting
Scene	It indicates the working mode of the camera. Outdoor: It applies to outdoor scenarios. Indoor: It applies to indoor scenarios.	[Configuration method] Select from the drop-down list [Default value] Outdoor
Mirror	It is used to select the pixel location of an image. Normal: The image does not flip. Horizontal: The image flips to the left and right. Vertical: The image flips up and down. Horizontal and vertical: The image rotates at 180 degrees.	[Setting method] Select a value from the drop-down list. [Default value] Normal

Step 3 Click **Apply** to save the setting.

---End

7.1.5 Exposure

Step 1 Choose **Setting > Quick Start > Display > Exposure** tag on the display interface, Figure 7-5 shows the **Exposure** interface.

Figure 7-5 Exposure interface for IP camera

Exposure ▼

Metering Mode Full Metering ▼

Exposure Mode Auto ▼

Max Shutter 1/30 ▼

Max Gain - + 50

Iris F1.6 ▼

Step 2 Set the parameters according to Table 7-3.

Table 7-3 Parameters of exposure

Parameter	Description	Setting
Metering Mode	<p>It is used to select the metering area.</p> <p>Fulling Metering: During metering, all areas of an image have equal weight, that is, all areas are involved in the metering.</p> <p>Spot Metering: During metering, the central spot of an image has the highest weight.</p> <p>Partial Metering: During metering, the middle area (1/2 of the total area) of an image has the highest weight, and other areas have the lowest weight.</p>	<p>[Setting method] Select a value from the drop-down list. [Default value] Whole</p>
Exposure Mode	<p>The exposure modes include:</p> <p>Auto: The system performs auto exposure based on the monitoring environment.</p> <p>Manual: You can adjust the brightness of an image by setting the following: Shutter Setting, Iris Setting, and Gain Setting.</p> <p>Shutter Priority: You can set Shutter Setting to fixed values. The iris and gain are automatically adjusted by the system.</p> <p>Iris Priority (for high-speed dome): You can set Iris Setting to fixed values. The shutter and gain are</p>	<p>[Setting method] Select a value from the drop-down list. [Default value] Auto</p>

Parameter	Description	Setting
	automatically adjusted by the system. Gain Setting: auto and manually to adjust.	
Max Shutter	The device automatically adjusts the shutter time based on the ambient brightness. The shutter time is less than or equal to the value of this parameter.	[Setting method] Select a value from the drop-down list. [Default value] 1/25
Max Gain	The device automatically adjusts the gain based on the external light. The gain is less than or equal to the value of this parameter.	[Setting method] Drag the slider. [Default value] 50
Iris	It indicates the auto adjustment speed of the iris. As the value increases, the speed increases. Excessive speed may cause instability.  NOTE This parameter is valid when the auto iris is enabled.	[Setting method] Drag the slider. [Default value] 50

Step 3 Click **Apply** to save the setting.

---End

7.1.6 White Balance Setting

Step 1 Choose **Setting > Quick Start > Display > White Balance** tag on the display interface, Figure 7-6 shows the **White Balance** interface.

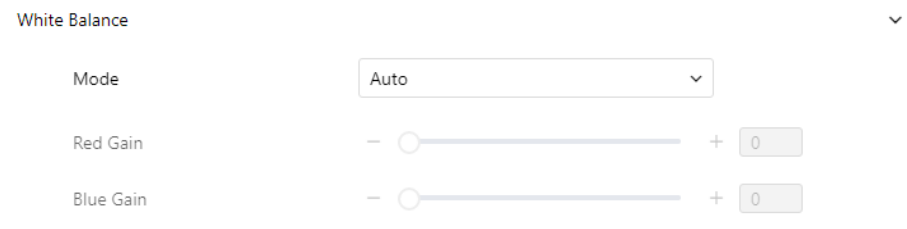

Figure 7-6 White balance settings page



Step 2 Set the parameters according to Table 7-4.

Table 7-4 Parameters of WB setting

Parameter	Description	Setting
Mode	Select WB mode according to	[Setting method]

Parameter	Description	Setting
	<p>different scenes for better image color reproduction.</p> <p>Auto: In automatic white balance (WB) mode, the system automatically performs white balance based on the monitoring environment.</p> <p>Tungsten</p> <p>Fluorescent</p> <p>Daylight</p> <p>Shadow</p> <p>Manual: In manual WB mode, you can manually select a WB mode based on the monitoring environment.</p>	<p>Select a value from the drop-down list.</p> <p>[Default value]</p> <p>Auto</p>
Red Gain	<p>It indicates the gain applied to red channels. As the value increases, the color temperature becomes lower.</p> <p> NOTE</p> <p>This parameter is valid when Manual Mode is set to Customized.</p>	<p>[Setting method]</p> <p>Drag the slider.</p> <p>[Default value]</p> <p>0</p>
Blue Gain	<p>It indicates the gain applied to blue channels. As the value increases, the color temperature becomes higher.</p> <p> NOTE</p> <p>This parameter is valid when Manual Mode is set to Customized.</p>	<p>[Setting method]</p> <p>Drag the slider.</p> <p>[Default value]</p> <p>0</p>

Step 3 Click **Apply** to save the setting.

---End

7.1.7 Day/Night

Step 1 Choose **Setting > Quick Start > Display > Day/Night** tag on the display interface. The day/night mode settings vary based on device models. For details, see the following sections. Figure 7-7 shows the **Day/Night** interface.

Figure 7-7 Day/Night page (timer)

Day/Night ▼

Setting Timer ▼

DTN Time 18 ▼ : 00 ▼

NTD Time 06 ▼ : 00 ▼

Figure 7-8 Day/Night mode page (auto)

Day/Night ▼

Setting Auto ▼

Delay(S) - + 5



TRANSI.(D->N) - + 70

TRANSI.(N->D) - + 30

Step 2 Set the parameters according to Table 7-5.

Table 7-5 Parameters of Day/Night

Parameter	Description	Setting
D/N Setting Mode	<p>It can be set to Auto, Day, Night, or Timer.</p> <p>Auto mode</p> <p>The image color and filter status are automatically switched based on the ambient brightness. The filter keeps infrared light from reaching the sensor during the day; The filter allows all light to reach the sensor at night.</p> <p>Day mode</p> <p>The image is colored, and the filter is in the day state, preventing infrared light from entering the sensor.</p> <p>Night mode</p> <p>The image is black and white, and the filter is in the night state, allowing infrared light to enter the sensor.</p> <p>Timer</p> <p>Switching between day mode and night mode according to the set time.</p>	<p>[Setting method]</p> <p>Select a value from the drop-down list.</p> <p>[Default value]</p> <p>Auto</p>

Parameter	Description	Setting
D/N Switch Sensitivity	The sensitivity of switching day and night. The higher value of sensitivity and the lower light intensity will switch to day.  NOTE This parameter is valid in auto mode.	[Setting method] Drag the slider. [Default value] 50
Delay(s)	The delay time of day to night or night to day.  NOTE This parameter is valid in auto mode.	[Setting method] Drag the slider. [Default value] 0
Illumination	For different models, you can choose the light modes, such as IR LED, White LED, Intelligent dual light (there are two lights in the camera, IR LED and white LED), and none. It depends on the performance of the cameras.	[Setting method] Select a value from the drop-down list.
DTN Time	Time of day to night.	[Setting method] Select a value from the drop-down list. [Default value] 18:00
NTD Time	Time of night to day.	[Setting method] Select a value from the drop-down list. [Default value] 6:00

Fill light settings

The camera fill light has four modes, including intelligent dual light (the current fill light will switch to warm light after an alarm is triggered, and switch back to the original fill light for fill light 30 s after the alert is released.), warm light, infrared lamp, and close (Choose to close the fill light and the color of the image will stay in the previous mode).

Different cameras can be set in different fill light modes, please set them according to the actual scene.

Day mode: It can be used in the scene with sufficient ambient light for 24 hours, where the image will be colorful without enabling the fill light.

Night mode: It can be used in a scene where there is insufficient ambient light for 24 hours, and turn on the fill light (it can be selected according to the four modes of the fill light).

Auto mode: Automatically switch the set fill light mode according to the brightness of the environment.

Timer mode: Set the start and end time of the day, this period is in day mode.

The brightness of the supplemental light can be set to either automatic or manual. In automatic mode, it adjusts based on the current environment. In manual mode, you can adjust the brightness by dragging the slider or setting a specific value.

Step 3 Click **Apply** to save the setting.

---End

7.1.8 Noise Reduction

Step 1 Choose **Setting > Quick Start > Display > Noise Reduction** tag on the display interface, Figure 7-9 shows the Noise Reduction interface.

Figure 7-9 Noise reduction page (auto)

Noise Reduction ▼

2D NR

Auto ▼

Max Strength -  +

3D NR

Auto ▼



Max Strength -  +

Figure 7-10 Noise reduction page (manual)

Noise Reduction ▼

2D NR

Manual ▼

Fixed Strength -  +

3D NR

Manual ▼

Fixed Strength -  +

Step 2 Set the parameters according to Table 7-6.

Table 7-6 Parameters of Noise Reduction

Parameter	Description	Setting
2D NR	Reduce the noise of the image.	[Configuration method] Select from the drop-down list [Default value] Auto
3D NR	Reduce the noise of the image.	[Configuration method] Select from the drop-down list [Default value] Auto

Parameter	Description	Setting
Max Strength	It is valid in auto noise filter mode. When the parameter value is 0 , the noise filter is disabled. When the parameter value is greater than 0 , the noise filter is enabled, and the system automatically adjusts the noise filter level based on the ambient brightness without exceeding the value of this parameter.	[Setting method] Drag the slider. [Default value] 50
Fixed Strength	It is valid in a manual noise filter mode.	[Setting method] Drag the slider. [Default value] 50

Step 3 Click **Apply** to save the setting.

---End

7.1.9 Image Enhancement

Step 1 Choose **Setting > Quick Start > Display > Image Enhancement** tag on the display interface, Figure 7-11 shows the enhanced image interface and Table 7-7 shows the enhanced image parameters.

Figure 7-11 Image enhancement page

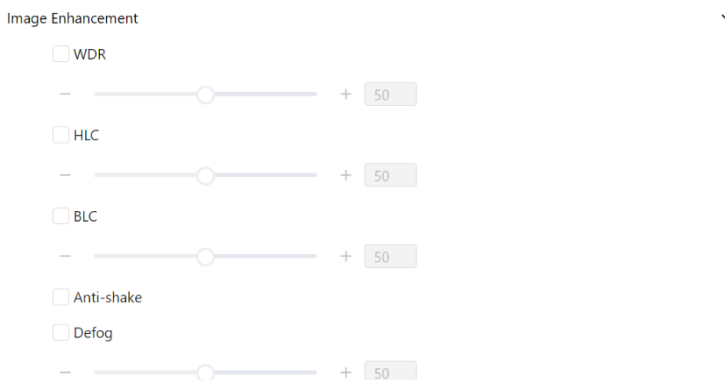

Step 2 Set the parameters according to Table 7-7.

Table 7-7 Parameters of enhanced image

Parameter	Description	Setting
WDR	It is used to display the foreground and background at the same time in the environment with a large brightness difference. When the brightness difference is larger, you can increase the WDR level to obtain a better image effect.	[Setting method] Tick the WDR mode and drag the slider. [Default value] 50
HLC	It provides a clearer view of an image in the highlight environment. When HLC is enabled, the total brightness of an image is reduced, allowing you to view objects in front of the highlight.	[Setting method] Tick the HLC mode and drag the slider. [Default value] 50
BLC	It provides a clearer view of an image in the backlight environment. When BLC is enabled, the total brightness of an image increases, allowing you to view objects in front of the backlight. Meanwhile, the objects behind the backlight are exposed excessively.	[Setting method] Tick the BLC mode and drag the slider. [Default value] 50
Anti-shake	The shakes and visual angle of the image will reduce when the camera shakes slightly and the anti-shake is enabled.	[Setting method] Tick the Anti-shake mode.
Defog	It provides a clearer view of an image in the fogged environment when DeFog is enabled. As the value increases, the image becomes clearer. Only applies to some models.	[Setting method] Tick the Defog mode and drag the slider. [Default value] 50

Step 3 Click **Apply** to save the setting.

---End

7.1.10 Zoom Focus

Choose **Setting > Quick Start > Display > Zoom Focus** tag on the display interface as shown in Figure 7-12.

Figure 7-12 Zoom focus

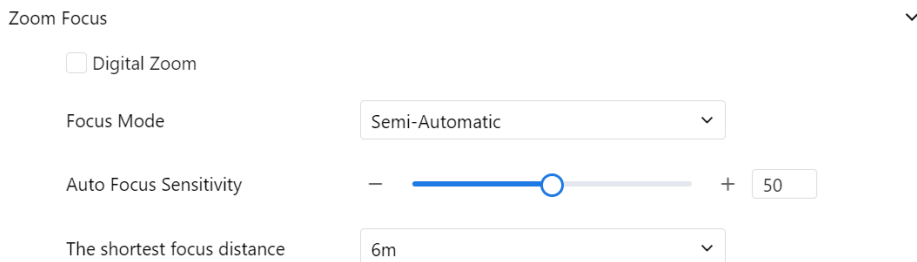



Table 7-8 Parameters of zoom focus

Parameter	Description	Setting
Digital Zoom	This function enables digital zoom after an image is zoomed in by 37 times in optical mode.	[Setting method] Tick the Digital Zoom.
Focus Mode	It can be set to the auto, manual, or semi-automatic mode. Auto focus mode: The system automatically triggers focus based on application scenarios. Manual focus mode: You can trigger focus by using the buttons on the client. Semi-automatic focus mode: The system only automatically triggers focus once when the PTZ moves or zooms in a scene.	[Configuration method] Select from the drop-down list [Default value] Semi-automatic
Auto Focus Sensitivity	It indicates the sensitivity of autofocus. When the sensitivity is high, the camera movement is more likely to focus again at slight changes in an image.	[Setting method] Drag the slider. [Default value] 50
The Least Focus Distance	It indicates the minimum focus distance. A camera does not focus when the distance is smaller than this value. For example, if the minimum focus distance is set to 1.5 m, a camera focuses only on objects more than 1.5 m away, and the changes in objects less than 1.5 m away do not affect the focus.  NOTE This parameter applies only to optical light.	[Configuration method] Select from the drop-down list [Default value] 6 m

7.2 Configure AI Multi-Target

Step 1 Choose **IVS > Deep Learning > AI Multi-Target** to set the parameter of the detected face, full body, and vehicle.

Figure 7-13 AI Multi-Target page

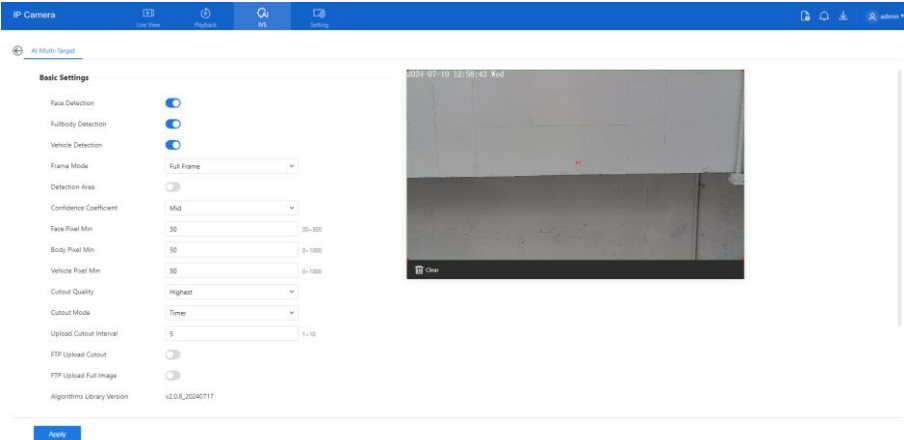

Table 7-9 lists the AI Multi-Target parameters.

Table 7-9 Parameters of AI Multi-Target

Parameter	Description	Setting
Face Detection	The camera will capture the face when someone appears in the live video.	Enable
Full body Detection	The camera will capture the whole body when someone appears in the live video.	Enable
Vehicle Detection	The camera will capture the vehicle when the vehicle appears in live video.	Enable
Frame Mode	Choose one to a trace box will show at live video. Four modes can be chosen, full frame, four-corner frame, mosaic, OFF. Users can also choose OFF to close the box on show.	Choose from the drop-down list.
Detection Area	Enable to show the detection area on live video.	--
Confidence Coefficient	The range of snapshots, there are three types, such as high, mid, and low. The higher the confidence, the better the snapshot quality and the fewer snapshots.	Choose from the drop-down list.

Parameter	Description	Setting
Face Pixel Min (30-300)	Face detection is on. It's the minimum face pixel that the device will capture. If the detected pixel is lower than the value, it will not be captured.	Input a value range of 30 to 300
Body Pixel Min (30-300)	Full body detection is on. It's the min full-body pixel that the device will capture. If the detected pixel is lower than the value, it will not be captured.	Input a value range of 30 to 300
Vehicle Pixel Min (30-300)	Vehicle detection is on. It's the minimum vehicle pixel that the device will capture. If the detected pixel is lower than the value, it will not be captured.	Input a value range of 30 to 300
Cutout Quality	For the quality of snapshots, four modes can be chosen, such as low, mid, high, and highest.	Choose from the drop-down list.
Cutout Mode	Two modes can be chosen, such as timing, and optimal.	Choose from the drop-down list.
Upload Cutout Interval	At timing mode, set the interval of the uploaded image. (1-10 s)	Input a value range of 1 to 10
FTP Upload Cutout	Configuration > Network Service > FTP set FTP-related parameters, the captured picture will be sent to the set FTP location.	Enable
FTP Upload Full Image	Capture a picture and send a whole image.	Enable

Step 2 For set deployment time, please refer to *Chapter 4.3 Step 4*.

Step 3 Click **Apply**. The message "Apply succeed!" is displayed, and the system will save the settings.

---End

7.3 Smoke and Flame Detection

The smoke flame detection function refers to that an alarm is generated when something is smoking or generating flame at the deployment area.

Select **IVS > Advanced Intelligent Analysis > Smoke and Flame Detection** to access the Smoke and Flame Detection interface, as shown in Figure 7-14.

Figure 7-14 Smoke and flame detection interface

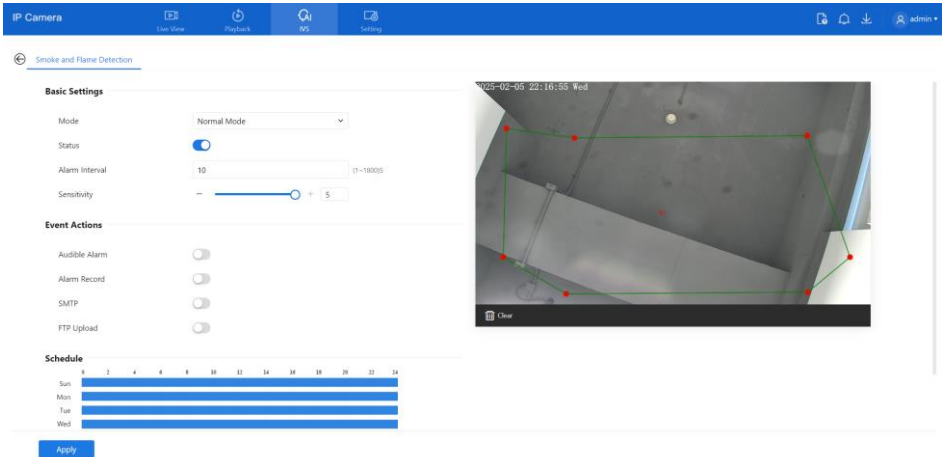

To set all parameters for smoke and flame detection, please refer to *Chapter 5.2.1*

---End

A Troubleshooting

Common Trouble	Possible Cause	Solution
Unable to access the web	The network is not connected.	Connect the network cable of the camera to the PC to check whether the network cable is in good contact. Run the ping command to check the network connection and whether the device works normally.
	The IP address is occupied.	Directly connect the camera to the PC, and reset the IP address of the camera.
	The IP addresses of the PC and the device are in different networks.	Check the IP address, subnet mask, and gateway setting of the camera.
PTZ or high-speed dome is out of control.	The protocol, bit rate, or address setting of the PTZ is incorrect.	Modify the address of the PTZ on the web.
	The signal cable is unconnected or not connected correctly.	Check the signal strength, and reconnect the signal cable.
The measured temperature is not accurate.	The device is just powered on, and the temperature of the cavity is unstable.	The temperature of the cavity is stable within 15 to 30 min after the device is powered on.
	The FFC mode is incorrect.	The FFC mode is automatic by default. If the mode is set to manual, there will be no block calibration, which may lead to fuzzy pictures and inaccurate temperature.
	The target configuration is incorrect.	Check whether the emission rate and distance of the target are configured correctly.

Common Trouble	Possible Cause	Solution
An error occurs in accessing the web of the device after the upgrade.	The data in the cache of the browser is not updated in time.	Delete the cache of the browser. The steps are as follows: <ol style="list-style-type: none"> 1. Press Ctrl + Shift + Delete and the pop-up window shows the Clear browsing data dialog box. 2. Select all checkboxes. 3. Click Clear now. 4. Relogin the web page of the camera.
Upgrade failed.	No network cable is connected.	Ensure the upgraded network is connected.
	The network setting is incorrect.	Check whether the network setting is correct.
	The upgrade package is incorrect.	Perform the correct upgrade package again.
No self-test no image output	There is a broken line in the circuit	Find breakpoints, and rewiring.
	Low supply voltage	Replace the power adapter to increase the output voltage.
Self-test exception	Low supply voltage	Replace the power adapter to increase the output voltage.
Equipment control is normal, image instability (Analog video)	Poor video circuit contact	Troubleshooting, rewiring
	Access device exception	Replacement access device
Equipment control is normal, image instability (Web video)	Network line bad contact	Dismantling bad points, re-wiring.
	Access to computer performance is insufficient, take up CPU usage	Lower stream and resolution
	Lack of network bandwidth	Replacement of industrial Gigabit switches
	Access decoder performance decoder	Replacement of high-performance

Common Trouble	Possible Cause	Solution
Self-test normal, cannot control	Wrong wiring	Rewiring
	Set the baud rate, protocol, address, and device mismatch	Screen configuration according to device parameters
Repeated restart	Insufficient supply voltage or voltage instability	To ensure that the input device voltage stability
Cannot control the lens to perform zoom and Focus action	Wiring error	Re-connect the lens control line
	Circuit board lens control problems	Replacement circuit board (please contact after-sales rework processing, do not replace parts or repair)
Cannot recall the set lens preset point	The DIP switch relative to the set lens preset dialing is not set to ON	DIP switch control lens preset dialing dial into ON
The image is lost when the control device rotates	Rotation process at the same location lost image	Conductive slip ring there is a bad contact, replace the parts (please contact after-sales rework, do not replace parts or repair)

B Common Emission Rate

Emission Rate

The emission rate is the capability of an object to emit or absorb energy. An ideal transmitter provides an emission rate of emitting 100% of intake energy. An object with an emission rate of 0.8 can absorb 80% of intake energy, and reflect the remaining 20%. The emission rate is the ratio of the energy emitted by an object at a specific temperature to that emitted by an ideal radiator at the same temperature. The range of emission rate value is 0.0 to 1.0 generally.

Materials	Temperature (°C/°F)	Emissivity
Gold (High-purity)	227/440	0.02
Aluminum foil	27/81	0.04
Aluminum sheet	27/81	0.18
Aluminum used for families (flat)	23/73	0.01
Aluminum plate (98.3% purity)	227/440	0.04
	577/1070	0.06
Aluminum plate (rough)	26/78	0.06
Aluminum (oxidized @ 599°C)	199/390	0.11
	599/1110	0.19
Polished aluminum	38/100	0.22
Tin (light tinned Iron sheet)	25/77	0.04
Nickel wire	187/368	0.1
Lead (99.9% purity, No oxidized)	127/260	0.06

Copper	199/390	0.18
Cobalt	599/1110	0.19
Steel	199/390	0.52
	599/1110	0.57
Tinned iron sheet (Light)	28/82	0.23
Brass(High-polish)	247/476	0.03
Brass (Tough rolled, polished metal wire)	21/70	0.04
Tinned Iron (Light)	-	0.13
Iron plate (Rust eaten)	20/68	0.69
Rolled steel sheet	21/71	0.66
Ferric oxide	100/212	0.74
Wrought-iron	21/70	0.94
Fused iron	1299-1399/2370-2550	0.29
Copper (Polished)	21-117/70-242	0.02
Copper(Polished, not reflected)	22/72	0.07
Copper (Heavy oxide Board)	25/77	0.78
Enamel (Fuse on iron)	19/66	0.9
Formica Plate	27/81	0.94
Frozen soil	-	0.93
Brick (Red, rough)	21/70	0.93
Brick (Unglazed, rough)	1000/1832	0.8

Carbon (T - carbon 0.9% ash)	127/260	0.81
Concrete	-	0.94
Glass (Glossy)	22/72	0.94
Granite (Surfaced)	21/70	0.85
Ice	0/32	0.97
Marble (I Polished, grey)	22/72	0.93
Asbestos board	23/74	0.96
Asbestos paper	38/100	0.93
	371/700	0.95
Asphalt (Paving the road)	4/39	0.97
Paper (Black tar)	-	0.93
Paper (White)	-	0.95
Plastic (White)	-	0.91

170-16-20-0064-03

V1.2